



SP Stainless Steel Submersible Pumps

Made in Taiwan



Catalogue 50 Hz

SP
General Data

Performance Range	01
SP 4"	02
SP 6"	04
SP 8"	06
SP 10"	08

Technical Data

SP 05	10
SP 10	12
SP 18	14
SP 25	16
SP 40	18
SP 70	20
SP 90	22
SP 150	26
SP 230	30
SP 300	34
SP 400	36
SP 500	38
SP 650	40
SP 800	44
SP 1100	48

SP 4" 6" 8" 10" Series Stainless Steel Submersible Pumps

SP4",6",8" and 10" submersible pumps are made of corrosion and abrasion resistant stainless steel and have been developed in accordance with state-of-the-art technology.

The SP series of pumps are manufactured to the highest standards for energy efficiency, dependable performance, rugged construction and long service life for the most demanding applications.

Performance Range

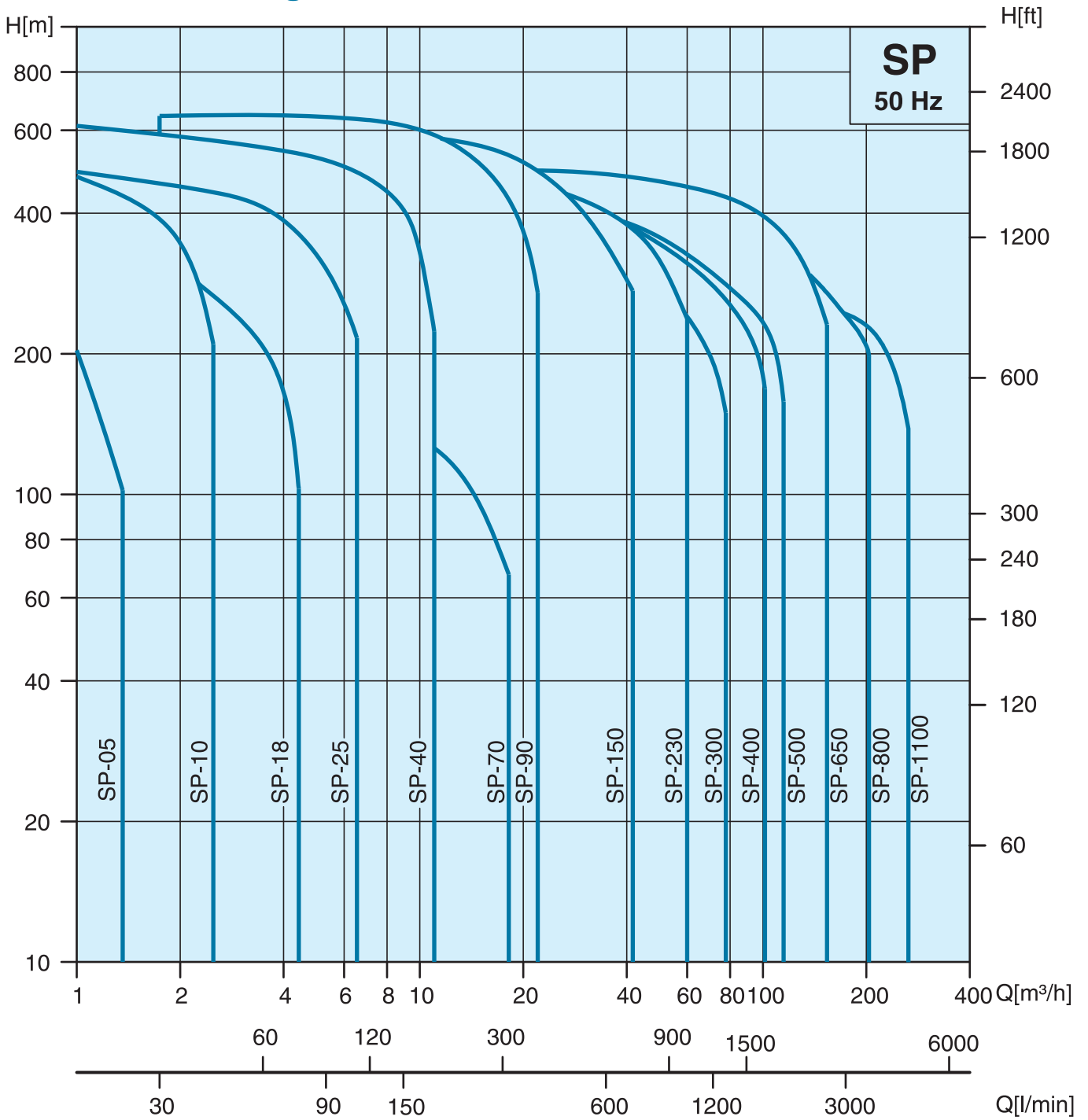

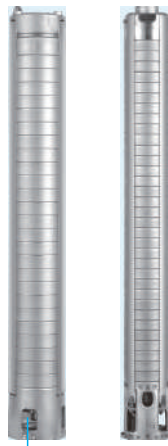

Model Code

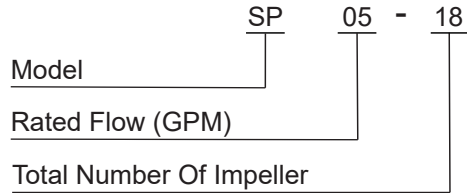

Screen size of each hole:

- ▣ 5x 1 mm (SP-05~10)
- ▣ Ø2.5 mm (SP-18~25)
- ▣ 20 x 4 mm (SP-40~70)

Applications

- Potable water supply
- Agricultural irrigation and livestock watering
- Municipal and industrial water supply
- Pressure boosting
- Mining applications
- Groundwater lowering
- Fountain

Pumped Liquids

- Clean, thin, non-aggressive and non-corrosive liquids without solid particles or fibers.

Operation Conditions

- Capacity (m³/h) min 0.3 max 18
- Total Head: Max. 625m
- Max. ambient temperature (Liquid): 50°C
- Sand content: Max. 50 g/m³

Features

- Stainless steel construction designed and built for years of trouble free operation
- Designed and built to operate in difficult conditions.
- All metal parts are made of 304 or 316 stainless steel, except for the shafts, which are made of 431, 304 or 316 stainless steel.
- Heavy duty stainless steel discharge head with built-in check valve for preventing back flow in connection with pump stoppage and the risk of destructive water hammer is reduced to a minimum.
- Smooth safety hook.
- NEMA standard of bracket mounting.
- High quality shaft bearings provide low friction and high wear resistance.
- The stop ring prevents damage to the pump during transport and in case of up-thrust in connection with start-up. The stop ring, which is designed as a thrust bearing, limits axial movements of the pump shaft.
- Stainless steel strainer to restrict the entry of sand and other extraneous material.

Materials

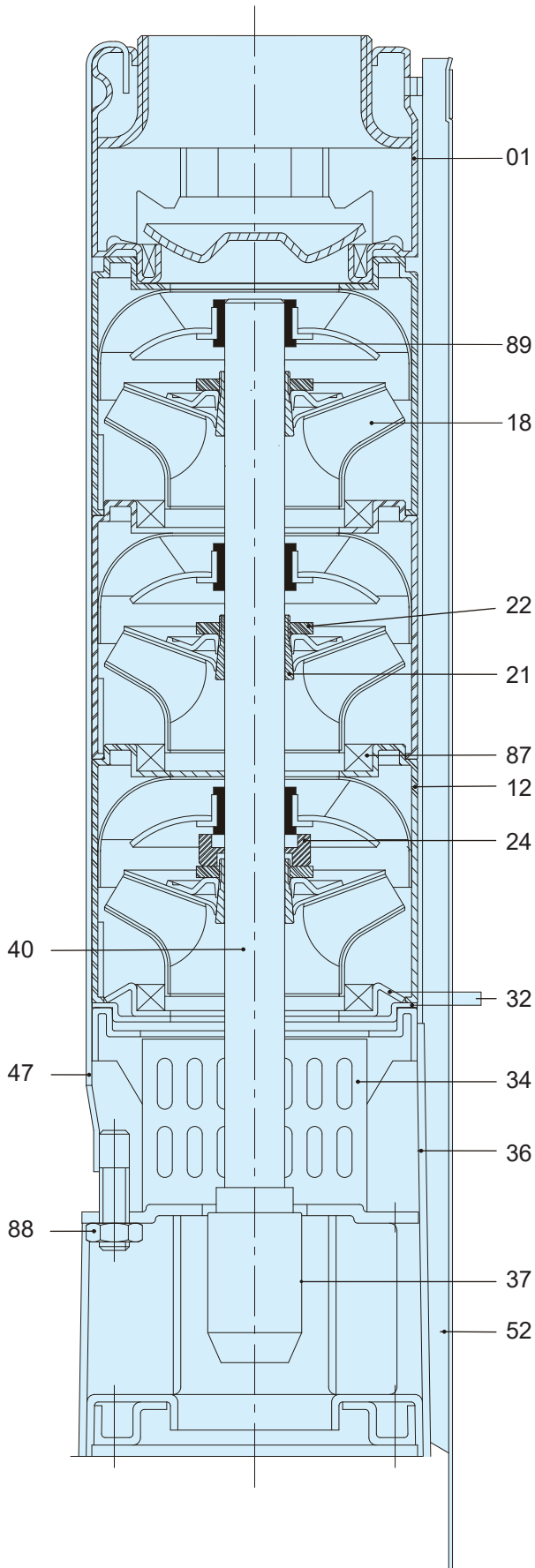

Pos.	Part Name	Materials
1	Discharge	SUS304 / SUS316
12	Diffuser	SUS304 / SUS316
18	Impeller	SUS304 / SUS316
21	Split Cone	SUS304 / SUS316
22	Split Cone Nut	SUS304 / SUS316
24	Stop Ring	Carbon+Graphite+PTFE
32	Neck Ring Retainer	SUS304 / SUS316
34	Strainer	SUS304 / SUS316
36	Suction Interconnector	SUS304 / SUS316
37	Coupling	SUS304 / SUS316
40	Pump Shaft	SUS304 / SUS431 / SUS316
47	Strap	SUS304 / SUS316
52	Cable Guard	SUS304 / SUS316
87	Neck Ring	SUS304+NBR / HNBR
88	Nut	SUS304 / SUS316
89	Bearing	NBR / HNBR

*AISI 316 stainless steel pumps are available on request.



Model Code

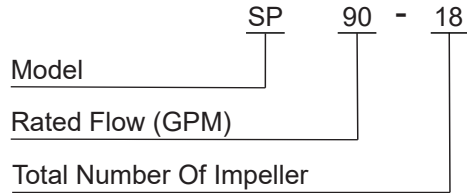

Screen size of each hole:
 20 x 4 mm

Applications

- Potable water supply
- Agricultural irrigation and livestock watering
- Municipal and industrial water supply
- Pressure boosting
- Mining applications
- Groundwater lowering
- Fountain

Pumped Liquids

- Clean, thin, non-aggressive and non-corrosive liquids without solid particles or fibers.

Operation Conditions

- Capacity (m³/h) min 3 max 78
- Total Head: Max. 648m
- Max. ambient temperature (Liquid): 40°C
- Sand content: Max. 50 g/m³

Features

- Stainless steel construction designed and built for years of trouble free operation
- Designed and built to operate in difficult conditions.
- All metal parts are made of 304 or 316 stainless steel, except for the shafts, which are made of 431, 304 or 316 stainless steel.
- Heavy duty stainless steel discharge head with built-in check valve for preventing back flow in connection with pump stoppage and the risk of destructive water hammer is reduced to a minimum.
- Smooth safety hook.
- NEMA standard of bracket mounting.
- High quality shaft bearings provide low friction and high wear resistance.
- The stop ring prevents damage to the pump during transport and in case of up-thrust in connection with start-up. The stop ring, which is designed as a thrust bearing, limits axial movements of the pump shaft.
- Stainless steel strainer to restrict the entry of sand and other extraneous material.

Materials

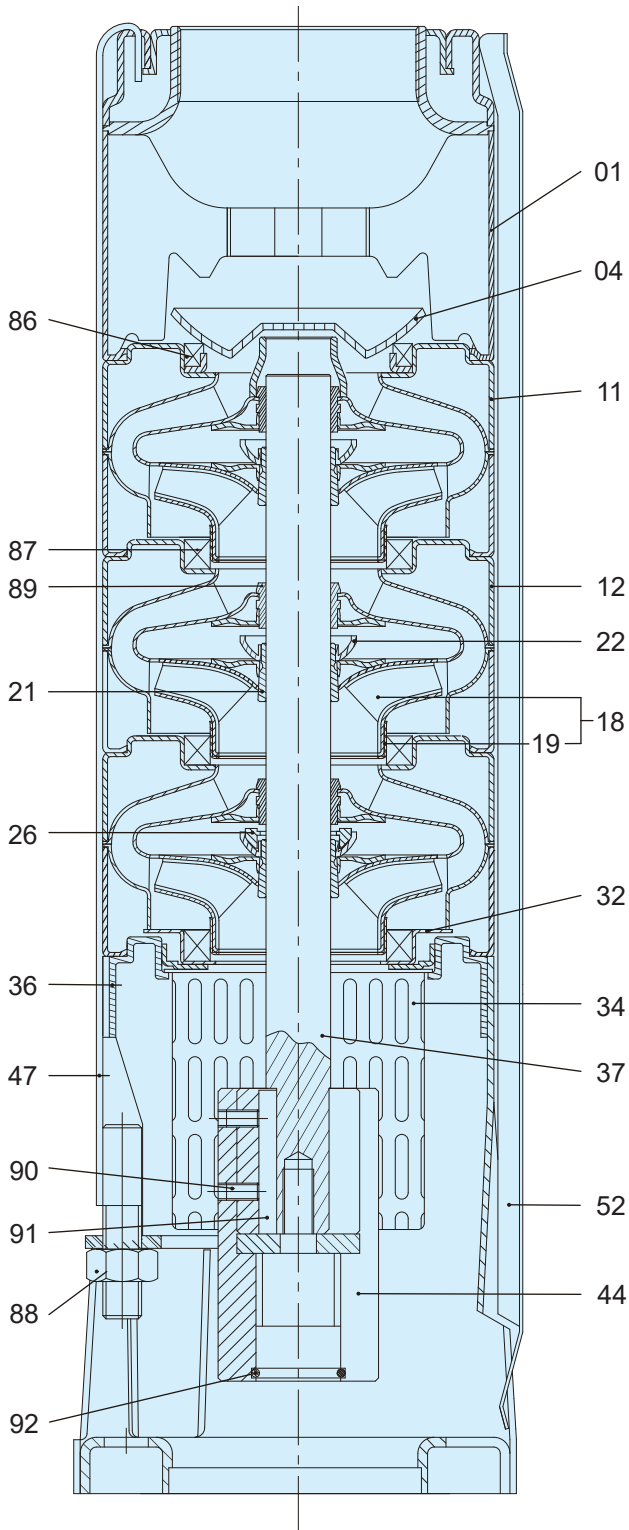

Pos.	Part Name	Materials
1	Discharge	SUS304 / SUS316
4	Valve Cone	SUS304 / SUS316
11	Top Diffuser	SUS304 / SUS316
12	Diffuser	SUS304 / SUS316
18	Impeller	SUS304 / SUS316
19	Ring of Impeller	SUS304 / SUS316
21	Split Cone	SUS304 / SUS316
22	Split Cone Nut	SUS304 / SUS316
26	Spacing Washer For Stop Ring	Carbon+Graphite+PTFE
32	Neck Ring Retainer	SUS304 / SUS316
34	Strainer	SUS304 / SUS316
36	Suction Interconnector	SUS304 / SUS316
37	Pump Shaft	SUS431 / SUS316
44	Coupling	SUS431 / SUS316
47	Strap	SUS304 / SUS316
52	Cable Guard	SUS304 / SUS316
86	Valve Seat	SUS304+NBR / HNBR
87	Neck Ring Nut	SUS304+NBR / HNBR
88	Nut	SUS304 / SUS316
89	Bearing	NBR / HNBR
90	Screw	SUS304 / SUS316
91	Key	SUS304 / SUS316
92	O-ring	NBR / HNBR

*AISI 316 stainless steel pumps are available on request.



Model Code

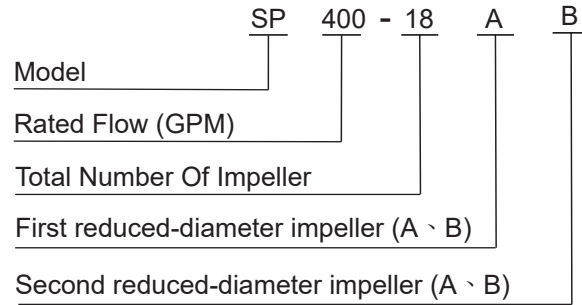

Screen size of each hole:
 20 x 4 mm

Applications

- Potable water supply
- Agricultural irrigation and livestock watering
- Municipal and industrial water supply
- Pressure boosting
- Mining applications
- Groundwater lowering
- Fountain

Pumped Liquids

- Clean, thin, non-aggressive and non-corrosive liquids without solid particles or fibers.

Operation Conditions

- Capacity (m³/h) min 12 max 120
- Total Head: Max. 450m
- Max. ambient temperature (Liquid): 40°C
- Sand content: Max. 50 g/m³

Features

- Stainless steel construction designed and built for years of trouble free operation
- Designed and built to operate in difficult conditions.
- All metal parts are made of 304 or 316 stainless steel, except for the shafts, which are made of 431, 304 or 316 stainless steel.
- Heavy duty stainless steel discharge head with built-in check valve for preventing back flow in connection with pump stoppage and the risk of destructive water hammer is reduced to a minimum.
- Smooth safety hook.
- NEMA standard of bracket mounting.
- High quality shaft bearings provide low friction and high wear resistance.
- The stop ring prevents damage to the pump during transport and in case of up-thrust in connection with start-up. The stop ring, which is designed as a thrust bearing, limits axial movements of the pump shaft.
- Stainless steel strainer to restrict the entry of sand and other extraneous material.

Materials

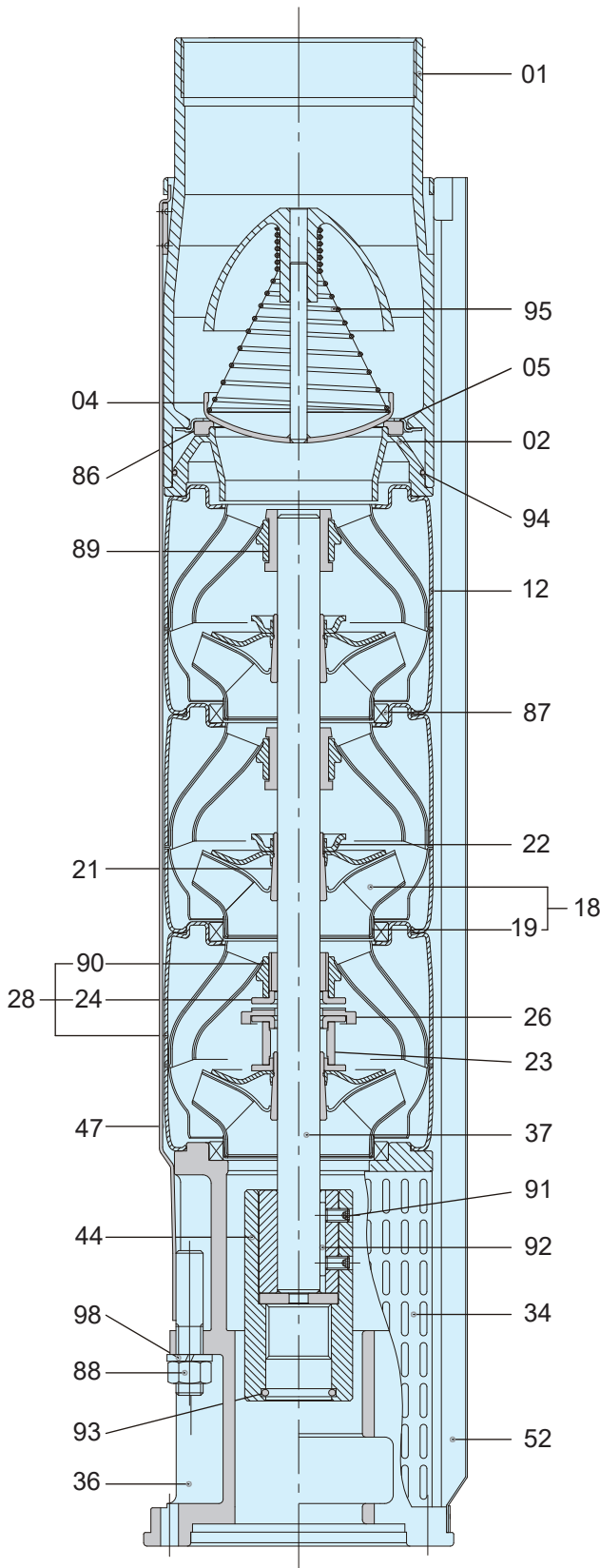

Pos.	Part Name	Materials
1	Discharge	SUS304 / SUS316
2	Lower Valve Seat Retainer	SUS304 / SUS316
4	Valve Cup	SUS304 / SUS316
5	Upper Valve Seat Retainer	SUS304 / SUS316
12	Diffuser	SUS304 / SUS316
18	Impeller	SUS304 / SUS316
19	Ring Of impeller	SUS304 / SUS316
21	Split Cone	SUS304 / SUS316
22	Split Cone Nut	SUS304 / SUS316
23	Nut For Stop Ring	SUS304 / SUS316
24	Stop Ring	SUS304 / SUS316
26	Spacing Washer For Stop Ring	Carbon+Graphite+PTFE
28	Bottom Diffuser	SUS304 / SUS316
34	Strainer	SUS304 / SUS316
36	Suction Interconnector	SUS304 / SUS316
37	Pump Shaft	SUS431 / SUS316
44	Coupling	SUS304 / SUS316
47	Strap	SUS304 / SUS316
52	Cable Guard	SUS304 / SUS316
86	Valve Seat	NBR / HNBR
87	Neck Ring	SUS304+NBR / HNBR
88	Nut	SUS304 / SUS316
89	Bearing	NBR / HNBR
90	Bearing	SUS304+NBR / SUS316+HNBR
91	Screw	SUS304 / SUS316
92	Key	SUS304 / SUS316
93	O-ring	NBR / HNBR
94	O-ring	NBR / HNBR
95	Spring	SUS304 / SUS316
98	Spring Washer	SUS304 / SUS316

*AISI 316 stainless steel pumps are available on request.



Model Code

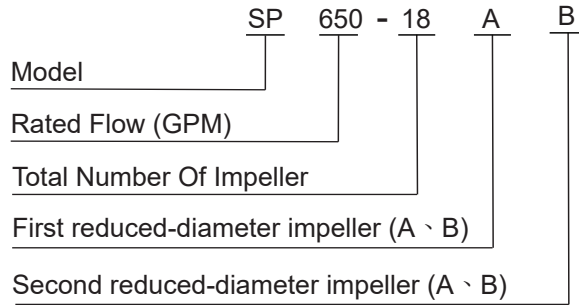

Screen size of each hole:
 20 x 4 mm

Applications

- Potable water supply
- Agricultural irrigation and livestock watering
- Municipal and industrial water supply
- Pressure boosting
- Mining applications
- Groundwater lowering
- Fountain

Pumped Liquids

- Clean, thin, non-aggressive and non-corrosive liquids without solid particles or fibers.

Operation Conditions

- Capacity (m³/h) min 16 max 280
- Total Head: Max. 502m
- Max. ambient temperature (Liquid): 40°C
- Sand content: Max. 50 g/m³

Features

- Stainless steel construction designed and built for years of trouble free operation
- Designed and built to operate in difficult conditions.
- All metal parts are made of 304 or 316 stainless steel, except for the shafts, which are made of 431, 304 or 316 stainless steel.
- Heavy duty stainless steel discharge head with built-in check valve for preventing back flow in connection with pump stoppage and the risk of destructive water hammer is reduced to a minimum.
- Smooth safety hook.
- NEMA standard of bracket mounting.
- High quality shaft bearings provide low friction and high wear resistance.
- The stop ring prevents damage to the pump during transport and in case of up-thrust in connection with start-up. The stop ring, which is designed as a thrust bearing, limits axial movements of the pump shaft.
- Stainless steel strainer to restrict the entry of sand and other extraneous material.

Materials

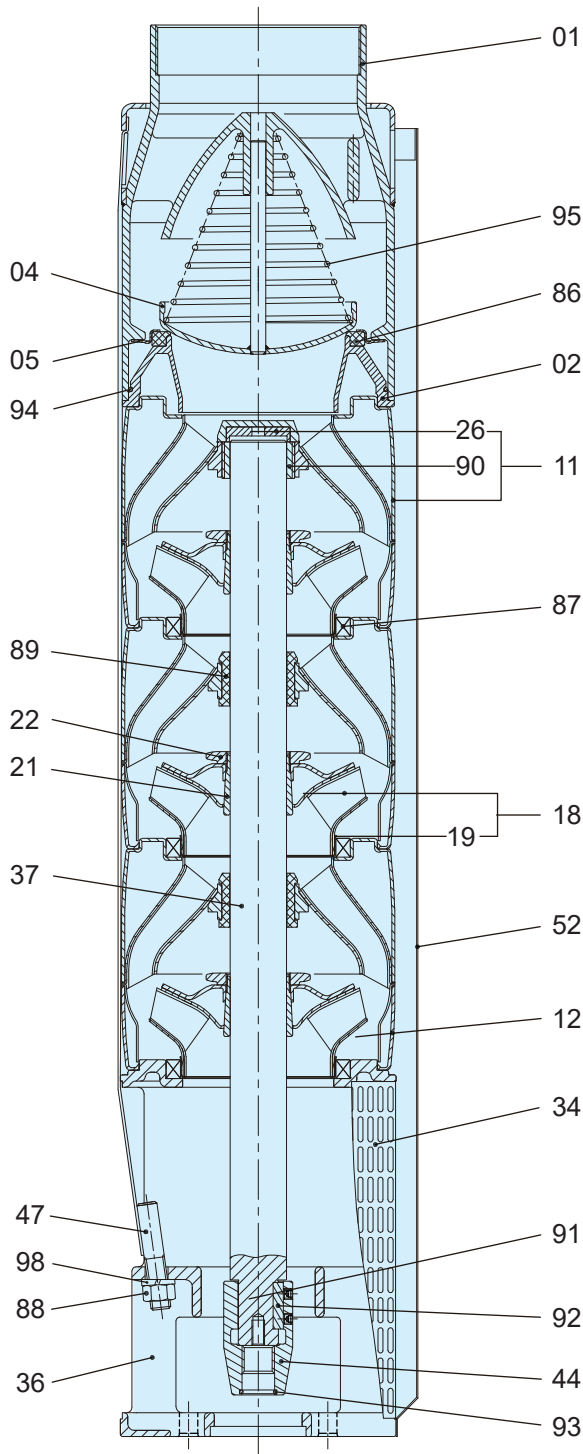

Pos.	Part Name	Materials
1	Discharge	SUS304 / SUS316
2	Lower Valve Seat Retainer	SUS304 / SUS316
4	Valve Cup	SUS304 / SUS316
5	Upper Valve Seat Retainer	SUS304 / SUS316
11	Upper Diffuser	SUS304 / SUS316
+26	Spacing Washer For Stop Ring	Carbon Fiber+MoS2+PTFE
+90	Upper Bearing	SUS304+NBGR0 / SUS316+HNBR
12	Diffuser	SUS304 / SUS316
18	Impeller	SUS304 / SUS316
18	Impeller-A	SUS304 / SUS316
+19	Ring Of Impeller	SUS304 / SUS316
21	Spit Cone	SUS304 / SUS316
22	Split Cone Nut	SUS304 / SUS316
34	Strainer-one lead	SUS304 / SUS316
34	Strainer-two leads	SUS304 / SUS316
36	Suction Interconnector-6"	SUS304 / SUS316
36	Suction Interconnector-8"	SUS304 / SUS316
37	Shaft	SUS431 / SUS316
44	Coupling-6"	SUS304 / SUS316
44	Coupling-8"	SUS304 / SUS316
47	Strap	SUS304 / SUS316
52	Cable Guard	SUS304 / SUS316
86	Valve Seat	NBR70 / HNBR70
87	Neck Ring	PPS+NBR / HNBR
88	Nut	SUS304 / SUS316
89	Bearing	NBR70 / HNBR70
91	Screw-6"	SUS304 / SUS316
91	Screw-8"	SUS304 / SUS316
92	Key-6"	SUS304 / SUS316
92	Key-8"	SUS304 / SUS316
93	O-ring-6"	NBR70/HNBR70
93	O-ring-8"	NBR70 / HNBR70
94	O-ring	NBR70 / HNBR70
95	Spring	SUS304 / SUS316
98	Spring Washer	SUS304 / SUS316

*AISI 316 stainless steel pumps are available on request.

Performance Curves

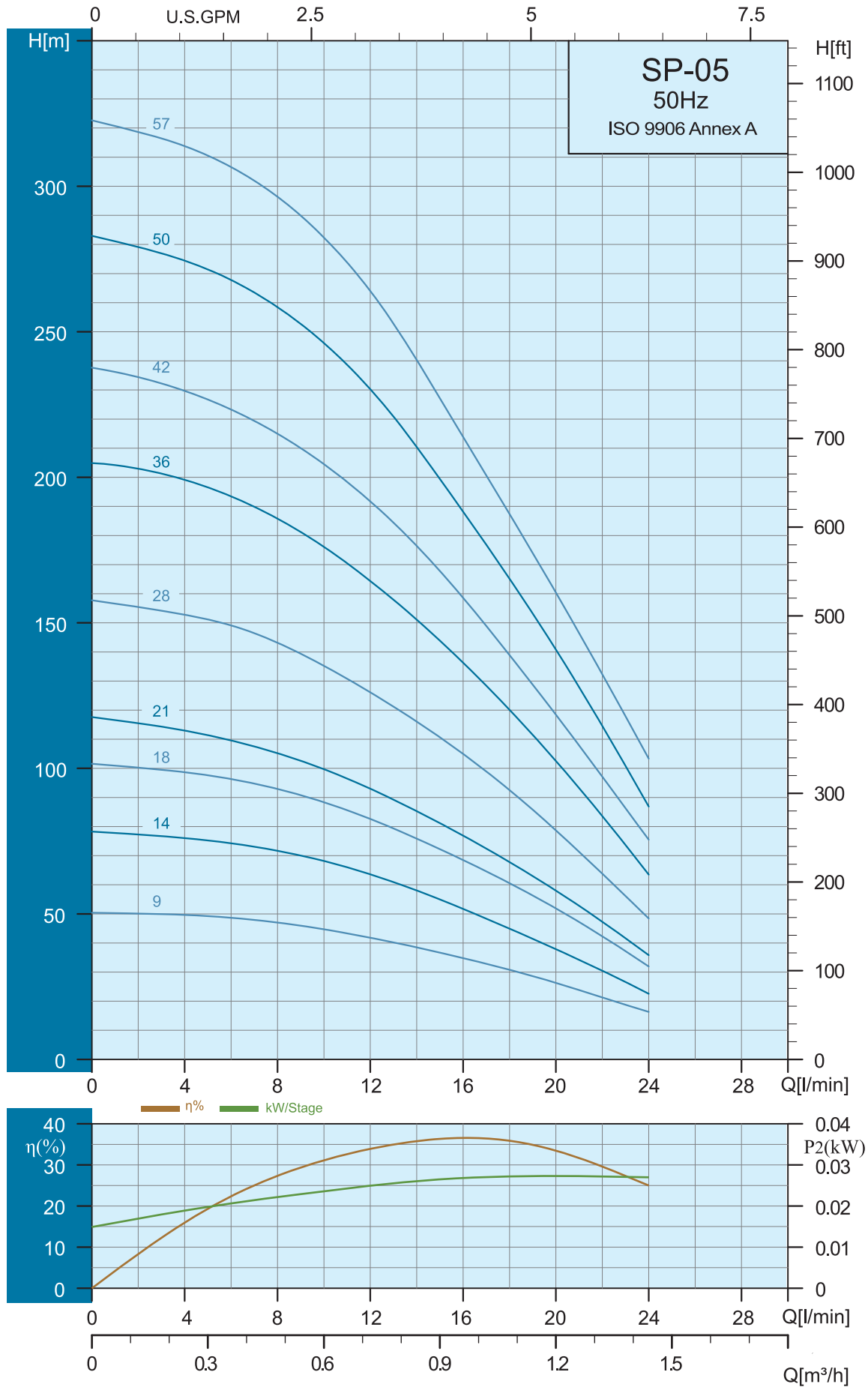

Specifications

Pump Type	Motor		Q=DELIVERY 2850rpm						
	P ₂		l/min	0	5	10	15	20	25
	kW	HP	m ³ /h	0	0.3	0.6	0.9	1.2	1.5
SP 05-09	0.37	0.5	H (m)	50.0	47.0	45.0	36.0	26.0	14.0
SP 05-14	0.37	0.5		78.0	75.0	68.0	55	38.0	21.0
SP 05-18	0.55	0.75		102.0	97.0	88.0	72.0	52.0	27.0
SP 05-21	0.55	0.75		118.0	111.0	100.0	81.0	58.0	30.0
SP 05-28	0.75	1.0		158.0	151.0	138.0	111.0	79.0	42.0
SP 05-36	1.1	1.5		205.0	196.0	175.0	144.0	103.0	54.0
SP 05-42	1.1	1.5		238.0	227.0	203.0	168.0	118.0	67.0
SP 05-50	1.5	2.0		283.0	271.0	246.0	199.0	140.0	72.5
SP 05-57	2.0	3.0		322.0	310.0	282.0	227.0	160.0	88.5

*Higher pressure , longer stages pumps up to 57 stages are available on request.

Dimensions and Weights

Pump Type	Motor Dia.	Dimensions (mm)			Net Weight (kg)
		A	B	C	
SP 05-09	4"	356	Rp 1 1/4" NPT 1 1/4"	98	2.9
SP 05-14	4"	461		98	3.7
SP 05-18	4"	545		98	4.4
SP 05-21	4"	608		98	5.0
SP 05-28	4"	755		98	6.2
SP 05-36	4"	946		98	9.9
SP 05-42	4"	1072		98	11.3
SP 05-50	4"	1240		98	13.2
SP 05-57	4"	1387		98	14.8

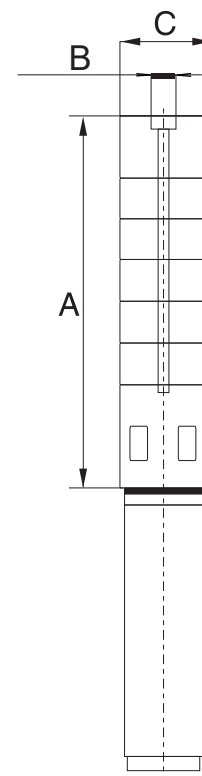

C=Maximum diameter of pump inclusive of cable guard and motor.

Performance Curves

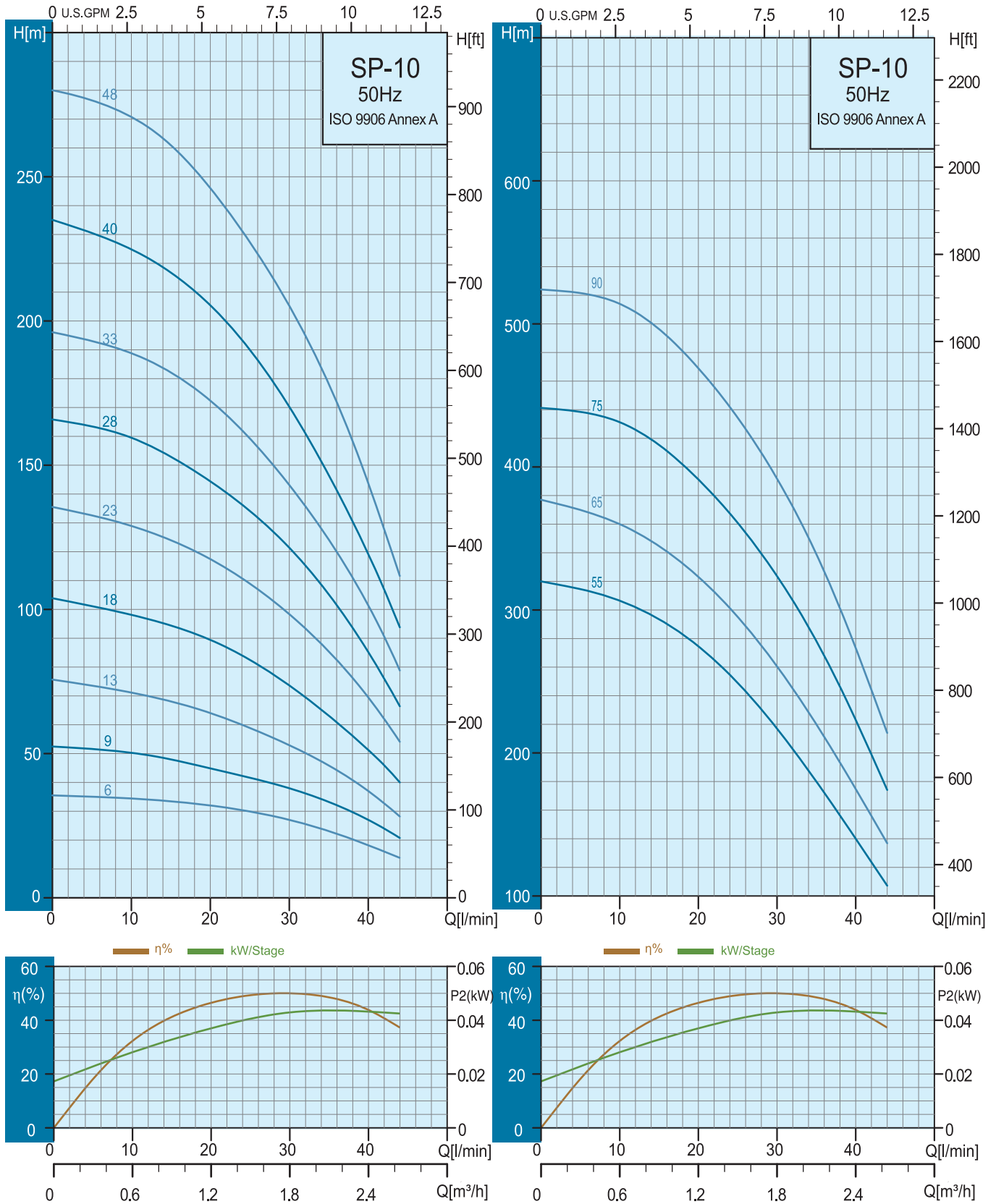

Specifications

Pump Type	Motor		Q=DELIVERY 2850rpm							
	P ₂		l/min	0	15	20	25	30	35	40
	kW	HP	m ³ /h	0	0.9	1.2	1.5	1.8	2.1	2.4
SP 10-06	0.37	0.5	H (m)	36.0	34.0	32.0	30.0	27.0	23.0	18.0
SP 10-09	0.37	0.5		52.0	48.0	45.0	42.0	38.0	33.0	27.0
SP 10-13	0.55	0.75		76.0	68.0	64.0	59.0	53.0	46.0	37.0
SP 10-18	0.75	1.0		104.0	94.0	89.0	82.0	74.0	63.0	51.0
SP 10-23	1.1	1.5		136.0	124.0	117.0	109.0	98.0	85.0	69.0
SP 10-28	1.5	2.0		166.0	153.0	144.0	134.0	121.0	105.0	85.0
SP 10-33	1.5	2.0		196.0	182.0	172.0	159.0	143.0	124.0	101.0
SP 10-40	2.2	3.0		235.0	217.0	205.0	190.0	170.0	147.0	119.0
SP 10-48	2.2	3.0		280.0	261.0	246.0	227.0	205.0	178.0	144.0
SP 10-55	3.0	4.0		320.0	293.0	275.0	249.0	217.0	180.0	140.0
SP 10-65	3.0	4.0		377.0	345.0	323.0	294.0	260.0	220.0	175.0
▶ SP 10-75	4.0	5.5		441.0	415.0	391.0	360.0	324.0	278.0	223.0
▶ SP 10-90	4.0	5.5		524.0	496.0	469.0	434.0	392.0	339.0	273.0

*Higher pressure, longer stages pumps up to 90 stages are available on request.

▶ With Sleeve

Dimensions and Weights

Pump Type	Motor Dia.	Dimensions (mm)			Net Weight (kg)
		A	B	C	
SP 10-06	4"	293	Rp 1 1/4" NPT 1 1/4"	98	2.3
SP 10-09	4"	356		98	3.0
SP 10-13	4"	440		98	3.8
SP 10-18	4"	545		98	4.7
SP 10-23	4"	650		98	5.7
SP 10-28	4"	755		98	6.6
SP 10-33	4"	883		98	9.7
SP 10-40	4"	1030		98	11.5
SP 10-48	4"	1198		98	13.5
SP 10-55	4"	1345		98	15.3
SP 10-65	4"	1555		98	17.8
▶ SP 10-75	4"	2123		133	40.1
▶ SP 10-90	4"	2438		133	45.6

C=Maximum diameter of pump inclusive of cable guard and motor.

SP 10-75 and SP 10-90 are mounted in sleeve for R 1 1/4 connection

▶ With Sleeve

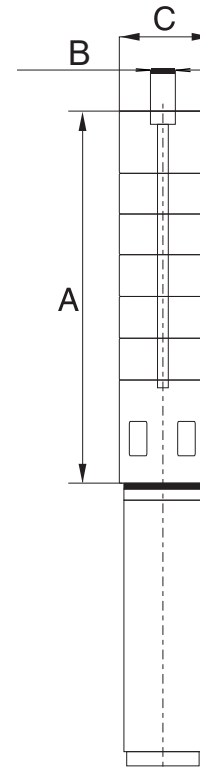

Performance Curves

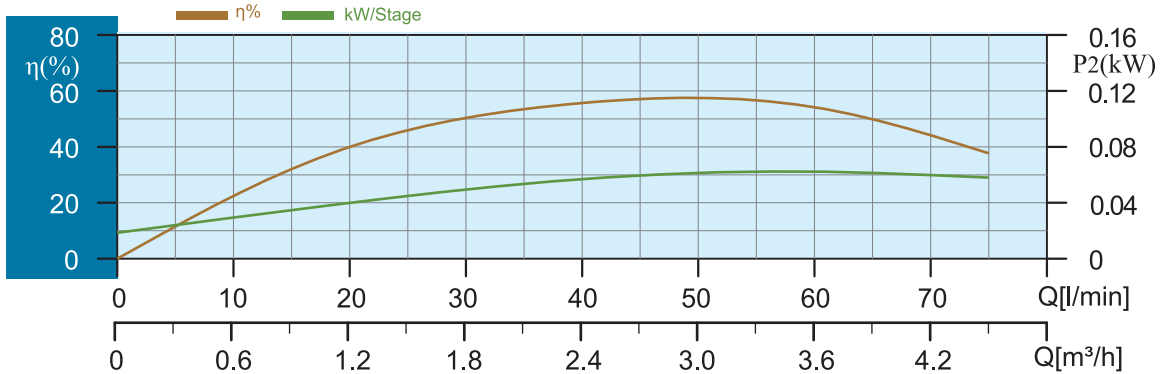
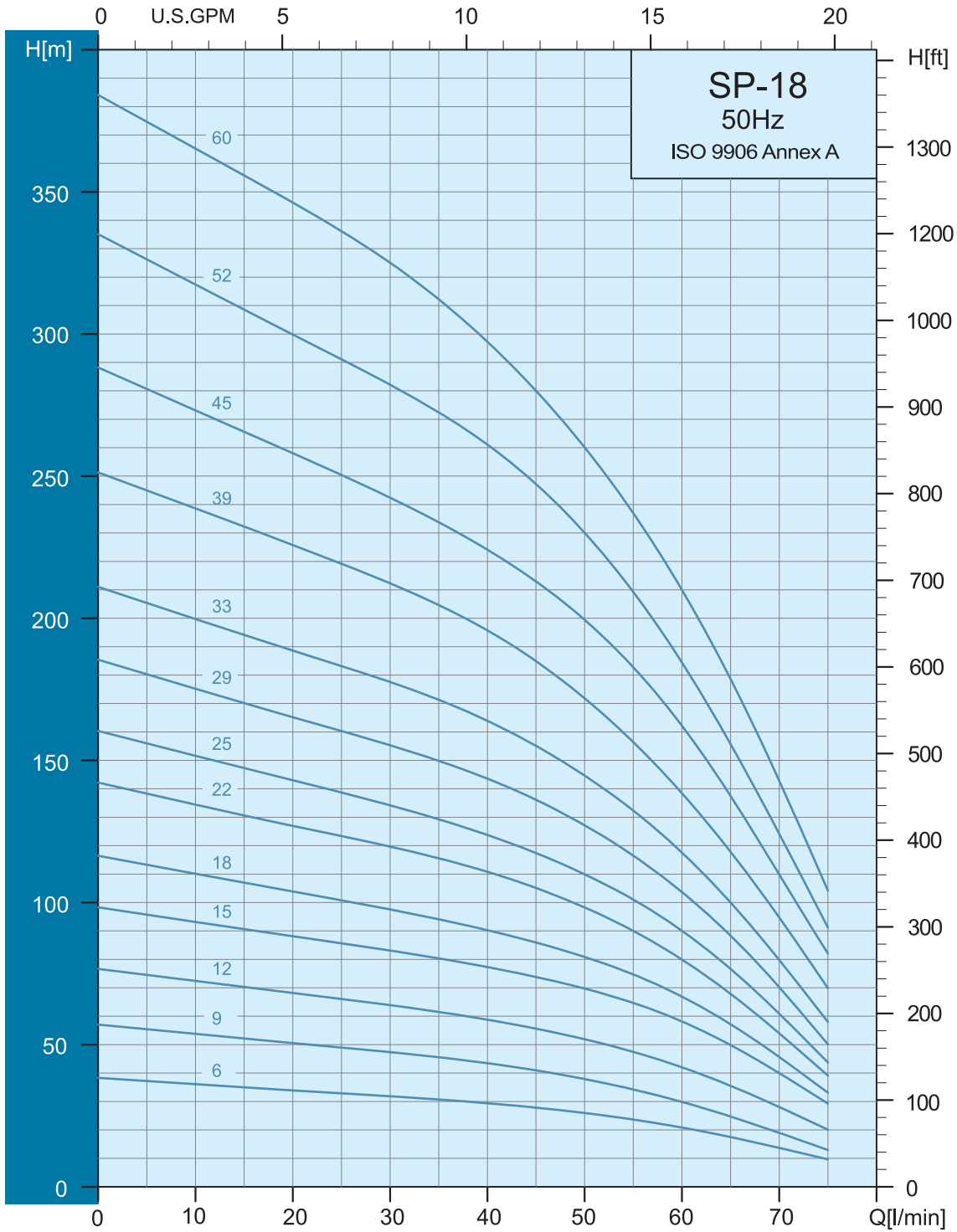

Specifications

Pump Type	Motor		Q=DELIVERY 2850rpm									
	P ₂		l/min	0	25	30	35	40	45	50	60	70
	kW	HP	m ³ /h	0	1.5	1.8	2.1	2.4	2.7	3.0	3.6	4.2
SP 18-06	0.37	0.5	H (m)	38.0	33.0	32.0	31.0	30.0	28.0	26.0	21.0	14.0
SP 18-09	0.55	0.75		57.0	49.0	47.0	46.0	43.0	41.0	38.0	30.0	19.0
SP 18-12	0.75	1.0		77.0	66.0	64.0	62.0	58.0	56.0	52.0	42.0	28.0
SP 18-15	1.1	1.5		97.0	85.0	83.0	80.0	77.0	74.0	69.0	57.0	40.0
SP 18-18	1.1	1.5		116.0	101.0	97.0	94.0	90.0	85.0	80.0	67.0	45.0
SP 18-22	1.5	2.0		142.0	123.0	120.0	115.0	110.0	105.0	98.0	80.0	54.0
SP 18-25	1.5	2.0		160.0	139.0	134.0	129.0	123.0	117.0	110.0	90.0	61.0
SP 18-29	2.2	3.0		185.0	160.0	155.0	150.0	143.0	136.0	127.0	103.0	70.0
SP 18-33	2.2	3.0		211.0	183.0	177.0	171.0	164.0	155.0	145.0	118.0	80.0
SP 18-39	3.0	4.0		251.0	219.0	212.0	205.0	196.0	185.0	172.0	138.0	95.0
SP 18-45	3.0	4.0		288.0	250.0	242.0	234.0	224.0	213.0	199.0	162.0	110.0
SP 18-52	4.0	5.5		334.0	291.0	282.0	272.0	261.0	247.0	230.0	184.0	124.0
SP 18-60	4.0	5.5		384.0	336.0	325.0	312.0	297.0	280.0	260.0	210.0	143.0

*Higher pressure , longer stages pumps up to 60 stages are available on request.

Dimensions and Weights

Pump Type	Motor Dia.	Dimensions (mm)			Net Weight (kg)
		A	B	C	
SP 18-06	4"	293	Rp 1 1/4" NPT 1 1/4"	98	2.4
SP 18-09	4"	356		98	3.0
SP 18-12	4"	419		98	3.6
SP 18-15	4"	482		98	4.2
SP 18-18	4"	545		98	4.7
SP 18-22	4"	629		98	5.5
SP 18-25	4"	692		98	6.1
SP 18-29	4"	776		98	6.8
SP 18-33	4"	883		98	9.7
SP 18-39	4"	1009		98	11.2
SP 18-45	4"	1135		98	12.7
SP 18-52	4"	1282		98	14.5
SP 18-60	4"	1450		98	16.6

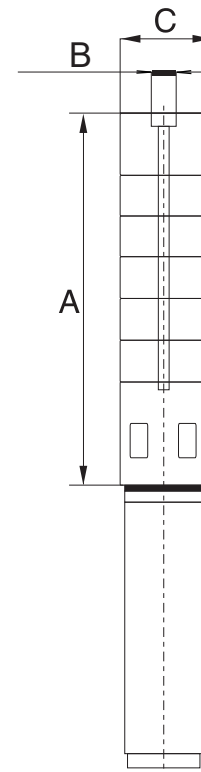

C=Maximum diameter of pump inclusive of cable guard and motor.

Performance Curves

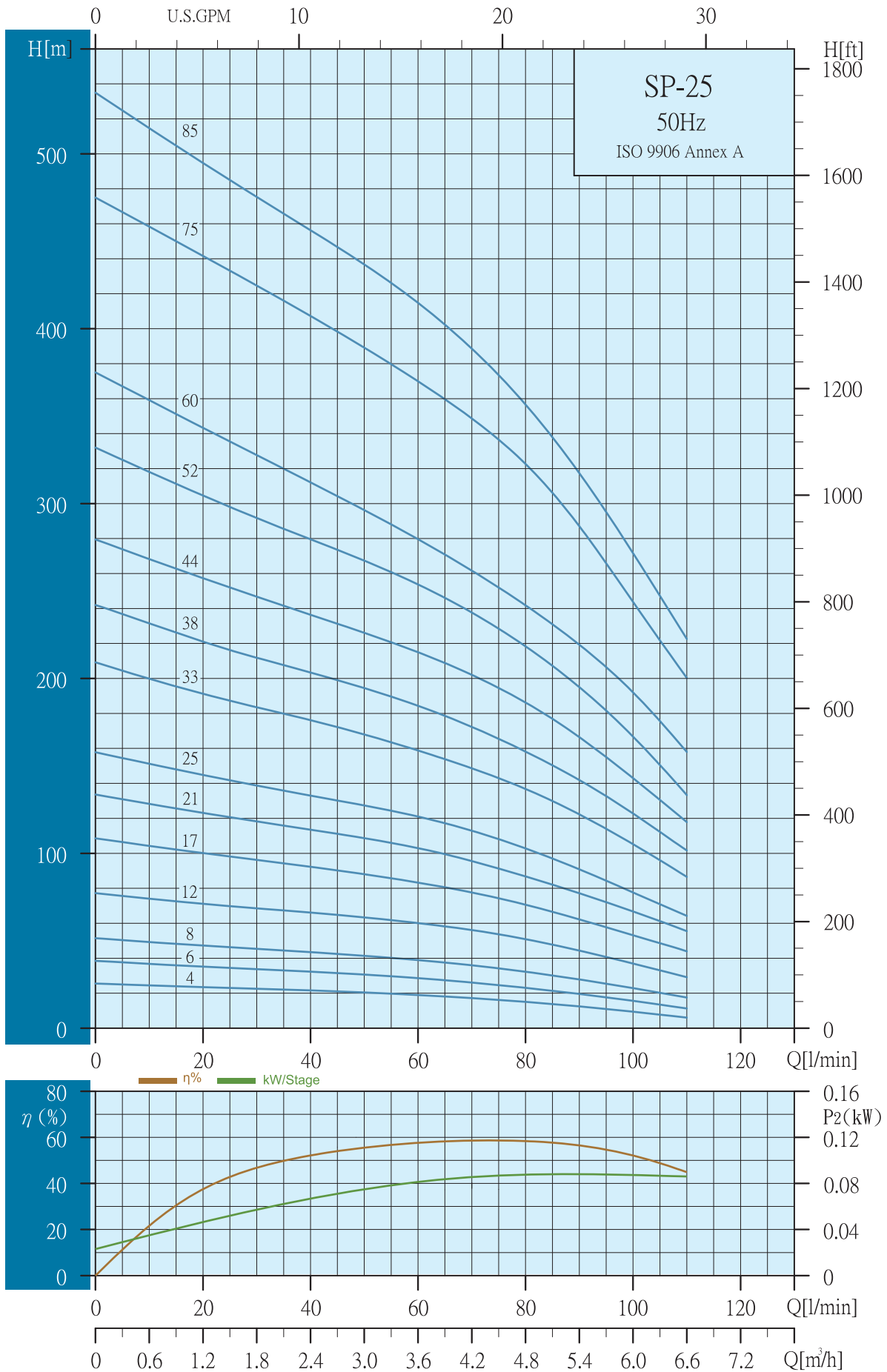

Specifications

Pump Type	Motor		l/min m ³ /h	Q=DELIVERY										
	P ₂			0	30	35	40	45	50	60	70	80	90	100
	kW	HP		0	1.8	2.1	2.4	2.7	3.0	3.6	4.2	4.8	5.4	6.0
SP 25-04	0.4	0.5	H (m)	25.0	23.0	22.0	21.0	20.5	20.0	19.0	17.0	15.0	12.0	10.0
SP 25-06	0.6	0.8		38.0	34.0	33.0	32.0	31.0	30.0	28.0	26.0	23.0	20.0	16.0
SP 25-08	0.8	1.0		51.0	45.0	44.0	43.0	42.0	41.0	39.0	36.0	32.0	28.0	23.0
SP 25-12	1.1	1.5		77.0	68.0	67.0	66.0	64.0	63.0	60.0	56.0	51.0	44.0	37.0
SP 25-17	1.5	2.0		108.0	96.0	94.0	92.0	90.0	88.0	83.0	77.0	70.0	62.0	53.0
SP 25-21	2.2	3.0		134.0	118.0	115.0	113.0	111.0	108.0	103.0	96.0	87.0	77.0	67.0
SP 25-25	2.2	3.0		157.0	138.0	136.0	133.0	130.0	127.0	121.0	113.0	103.0	90.0	78.0
SP 25-33	3.0	4.0		209.0	184.0	180.0	176.0	172.0	168.0	159.0	149.0	137.0	122.0	105.0
SP 25-38	4.0	5.5		242.0	212.0	208.0	203.0	199.0	194.0	184.0	172.0	158.0	142.0	123.0
SP 25-44	4.0	5.5		279.0	247.0	242.0	237.0	231.0	226.0	215.0	202.0	187.0	166.0	143.0
SP 25-52	5.5	7.5		332.0	291.0	285.0	279.0	273.0	267.0	253.0	237.0	218.0	195.0	166.0
SP 25-60	5.5	7.5		375.0	327.0	320.0	312.0	304.0	296.0	279.0	261.0	242.0	219.0	192.0
▶ SP 25-75	7.5	10.0		475.0	424.0	416.0	407.0	398.0	389.0	370.0	348.0	322.0	287.0	243.0
▶ SP 25-85	7.5	10.0		535.0	475.0	466.0	456.0	446.0	436.0	414.0	388.0	356.0	317.0	271.0

*Higher pressure , longer stages pumps up to 85 stages are available on request.

▶With Sleeve

Dimensions and Weights

Pump Type	Motor Dia.	Dimensions (mm)			Net Weight (kg)
		A	B	C	
SP 25-04	4"	251	Rp 1 1/2" NPT 1 1/2"	98	2.0
SP 25-06	4"	293		98	2.4
SP 25-08	4"	335		98	2.8
SP 25-12	4"	419		98	3.6
SP 25-17	4"	524		98	4.5
SP 25-21	4"	608		98	5.3
SP 25-25	4"	692		98	6.0
SP 25-33	4"	868		98	9.6
SP 25-38	4"	973		98	10.9
SP 25-44	4"	1099		98	12.4
SP 25-52	4"	1267		98	14.4
SP 25-52	6"	1341		138	16.5
SP 25-60	4"	1435		98	16.4
SP 25-60	6"	1509		138	18.5
▶ SP 25-75	6"	2171	140	41.5	
▶ SP 25-85	6"	2335	140	45.5	

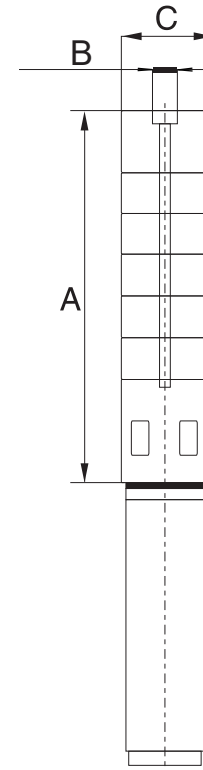

C=Maximum diameter of pump inclusive of cable guard and motor.
SP 25-75 and SP 25-85 are mounted in sleeve for R 1 1/2 connection

▶With Sleeve

Performance Curves

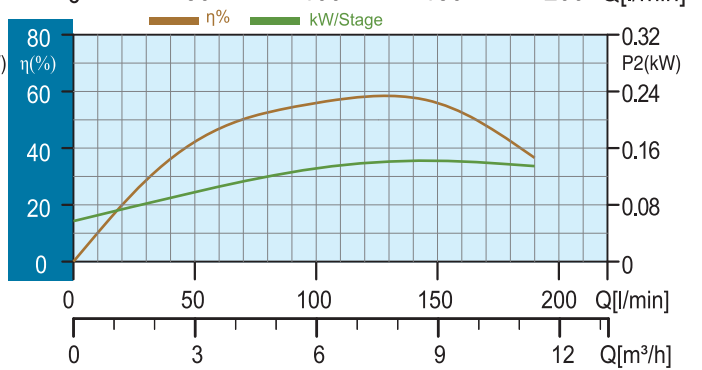
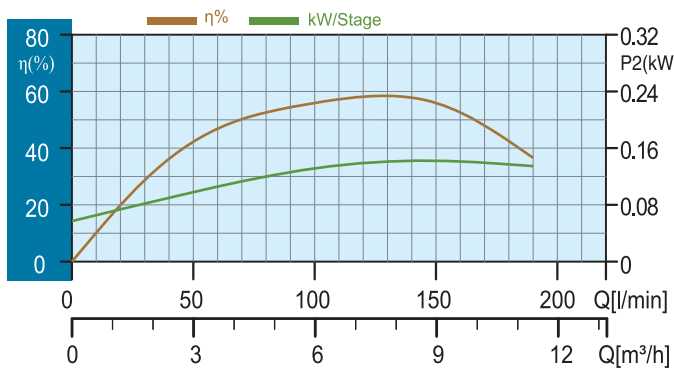
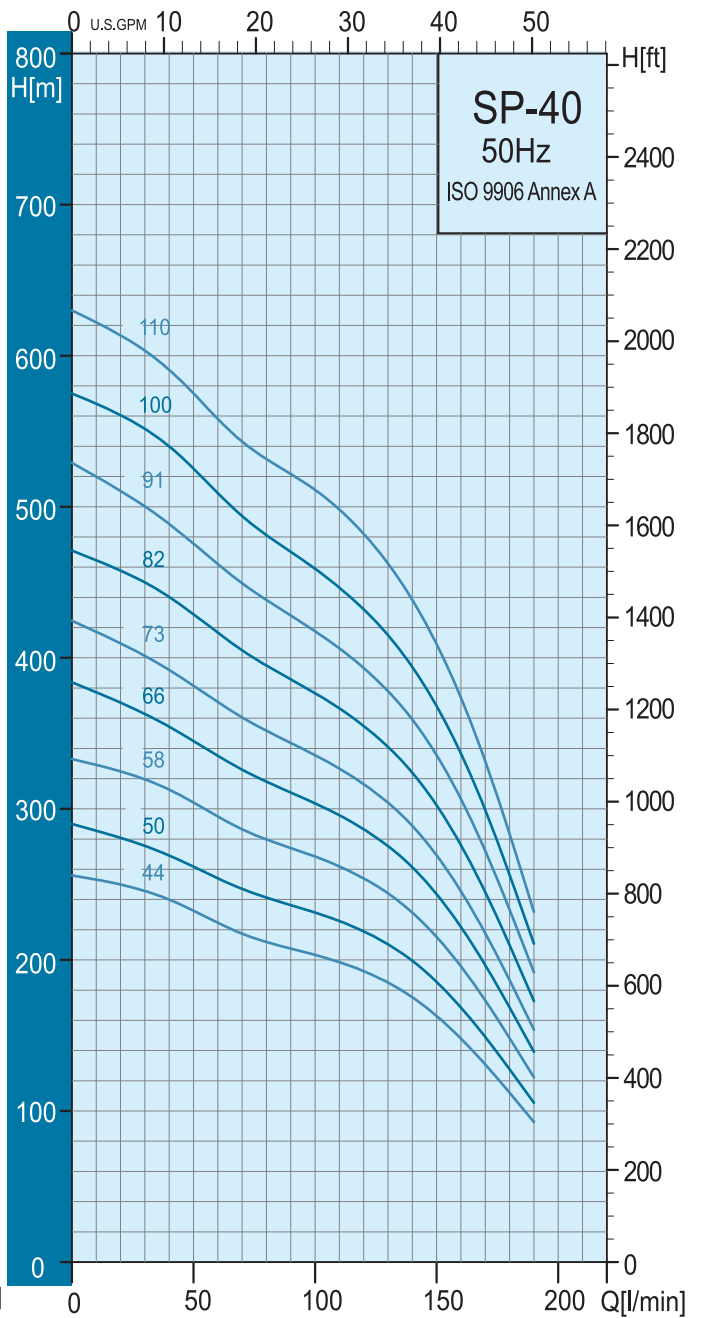
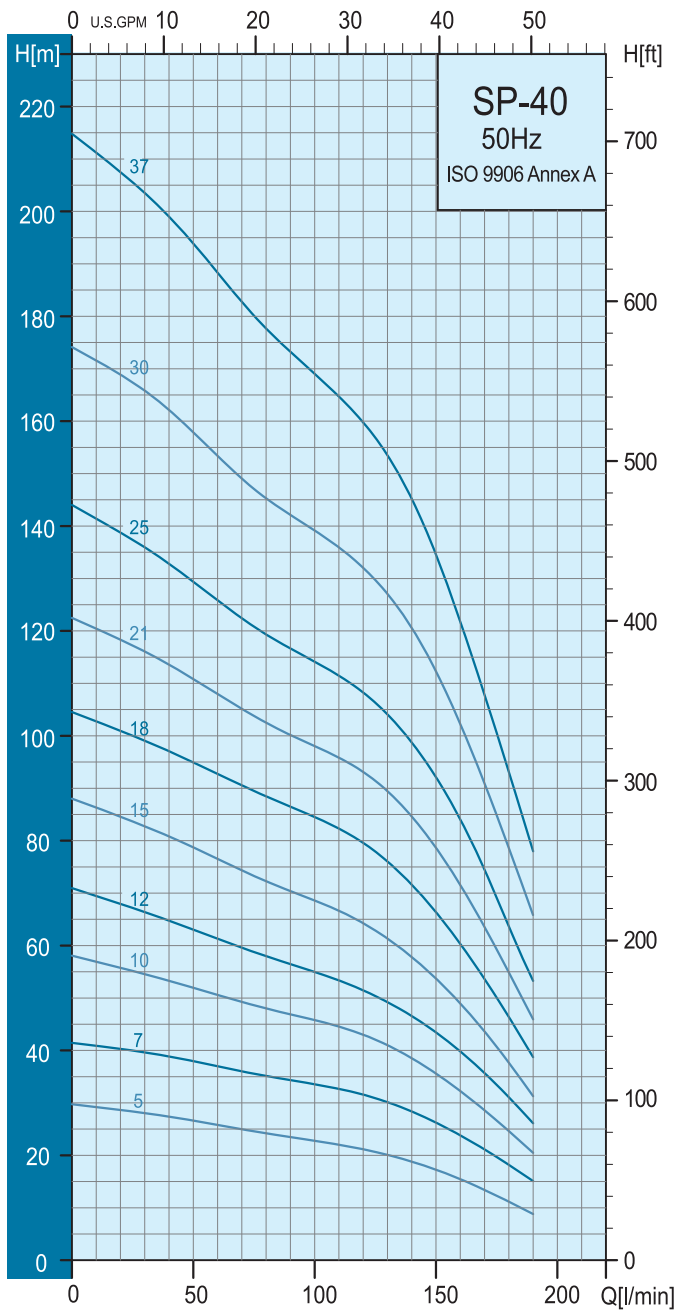

Specifications

Pump Type	Motor		Q=DELIVERY 2850rpm													
	P ₂		l/min	0	40	45	50	60	70	80	90	100	120	140	160	180
	kW	HP	m ³ /h	0	2.4	2.7	3.0	3.6	4.2	4.8	5.4	6.0	7.2	8.4	9.6	10.8
SP 40-05	0.8	1.0	H (m)	30.0	28.0	27.0	26.0	26.0	25.0	24.0	23.0	22.0	21.0	19.0	15.0	11.0
SP 40-07	1.1	1.5		41.0	39.0	38.0	38.0	37.0	36.0	35.0	34.0	33.0	32.0	28.0	24.0	18.0
SP 40-10	1.5	2.0		58.0	54.0	53.0	52.0	51.0	49.0	48.0	47.0	46.0	43.0	38.0	32.0	25.0
SP 40-12	2.2	3.0		71.0	65.0	64.0	63.0	61.0	60.0	58.0	56.0	55.0	52.0	47.0	40.0	31.0
SP 40-15	2.2	3.0		88.0	80.0	79.0	78.0	76.0	74.0	72.0	70.0	68.0	64.0	57.0	49.0	38.0
SP 40-18	3.0	4.0		104.0	98.0	96.0	95.0	93.0	90.0	88.0	86.0	84.0	79.0	72.0	60.0	46.0
SP 40-21	4.0	5.5		122.0	114.0	112.0	111.0	107.0	105.0	102.0	100.0	98.0	93.0	85.0	72.0	55.0
SP 40-25	4.0	5.5		144.0	133.0	131.0	129.0	126.0	122.0	119.0	116.0	114.0	108.0	98.0	84.0	64.0
SP 40-30	5.5	7.5		174.0	163.0	160.0	157.0	154.0	149.0	145.0	142.0	139.0	132.0	120.0	102.0	79.0
SP 40-37	5.5	7.5		215.0	199.0	196.0	194.0	188.0	183.0	177.0	173.0	169.0	160.0	145.0	122.0	93.0
SP 40-44	7.5	10.0		256.0	240.0	236.0	232.0	224.0	217.0	212.0	207.0	203.0	192.0	175.0	148.0	112.0
SP 40-50	7.5	10.0		290.0	269.0	266.0	261.0	254.0	247.0	241.0	236.0	231.0	219.0	199.0	168.0	127.0
SP 40-58	11.0	15.0		333.0	312.0	309.0	304.0	295.0	286.0	280.0	274.0	268.0	254.0	231.0	195.0	148.0
SP 40-66	11.0	15.0		383.0	354.0	350.0	345.0	335.0	326.0	318.0	311.0	303.0	286.0	261.0	222.0	168.0
SP 40-73	11.0	15.0		424.0	392.0	387.0	381.0	370.0	360.0	351.0	343.0	335.0	316.0	289.0	245.0	186.0
SP 40-82	15.0	20.0		471.0	440.0	429.0	429.0	416.0	405.0	395.0	385.0	376.0	355.0	324.0	276.0	210.0
SP 40-91	15.0	20.0		529.0	488.0	482.0	475.0	462.0	449.0	438.0	428.0	417.0	393.0	359.0	306.0	233.0
SP 40-100	18.5	25.0		575.0	540.0	533.0	525.0	509.0	493.0	481.0	470.0	459.0	432.0	394.0	336.0	256.0
SP 40-110	18.5	25.0	630.0	590.0	583.0	575.0	558.0	543.0	531.0	521.0	511.0	482.0	438.0	373.0	283.0	

*Higher pressure , longer stages pumps up to 110 stages are available on request.
 ► With Sleeve

Dimensions and Weights

Pump Type	Motor Dia.	Dimensions (mm)			Net Weight (kg)
		A	B	C	
SP 40-05	4"	412	Rp 2" NPT 2"	98	4.3
SP 40-07	4"	496		98	5.3
SP 40-10	4"	622		98	6.8
SP 40-12	4"	706		98	7.8
SP 40-15	4"	832		98	9.3
SP 40-18	4"	958		98	10.8
SP 40-21	4"	1084		98	12.3
SP 40-25	4"	1252		98	14.3
SP 40-30	4"	1462		98	16.8
SP 40-37	4"	1753		98	20.3
SP 40-44	4"	2047		98	23.3
SP 40-44	6"	2113		138	25.5
SP 40-50	4"	2299		98	26.4
SP 40-50	6"	2365		138	28.5
SP 40-58	6"	3005		140	58.2
SP 40-66	6"	3341		140	64.6
SP 40-73	6"	3635		140	70.4
SP 40-82	6"	4013		140	77.7
SP 40-91	6"	4391	140	85.1	
SP 40-100	6"	4769	140	92.4	
SP 40-110	6"	5189	140	100.6	

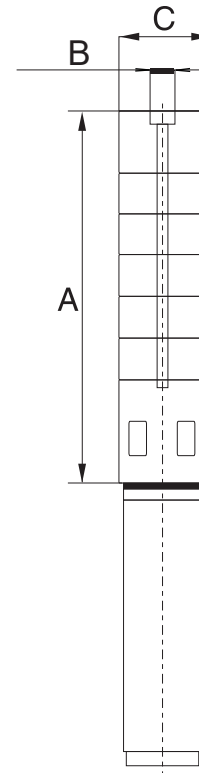

C=Maximum diameter of pump inclusive of cable guard and motor.
 SP 40-58 to SP 40-110 are mounted in sleeve for R 2 connection
 ► With Sleeve

Performance Curves

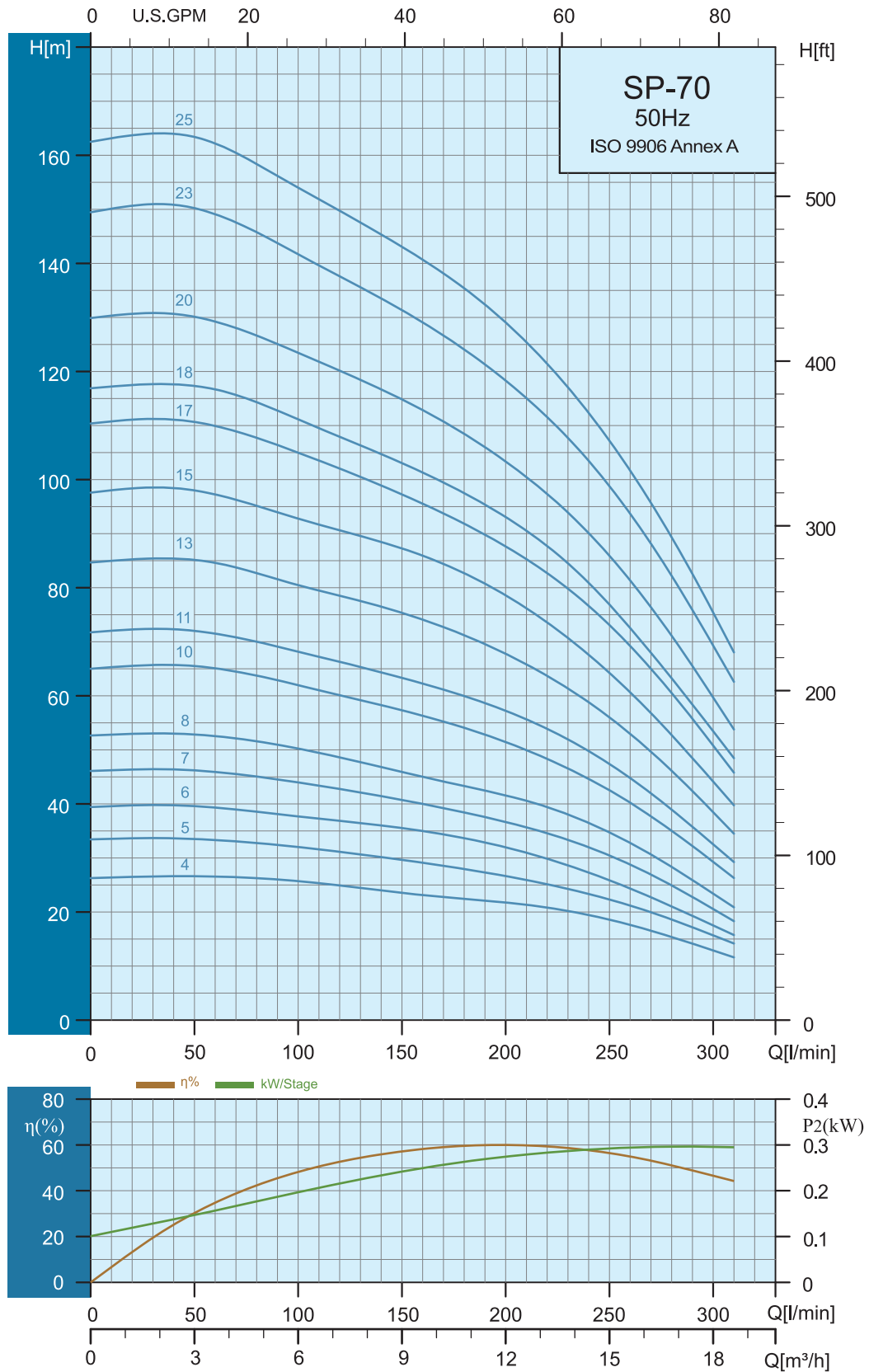

Specifications

Pump Type	Motor		Q=DELIVERY 2850rpm									
	P ₂		l/min	0	100	120	140	160	180	200	250	300
	kW	HP	m ³ /h	0	6.0	7.2	8.4	9.6	10.8	12.0	15.0	18.0
SP 70-04	1.1	1.5	H (m)	26.0	25.5	25.0	24.0	23.0	22.5	21.5	18.5	13.0
SP 70-05	1.5	2.0		33.0	32.0	31.0	30.0	29.0	28.0	26.0	22.0	16.0
SP 70-06	2.2	3.0		39.5	37.5	37.0	36.0	35.0	33.5	32.0	26.0	17.5
SP 70-07	2.2	3.0		46.0	44.0	43.0	42.0	40.0	38.0	36.0	30.0	20.0
SP 70-08	3.0	4.0		52.5	50.0	48.5	46.5	45.0	43.0	41.5	35.0	23.5
SP 70-10	3.0	4.0		65.0	62.0	60.0	58.0	56.0	54.0	51.0	43.0	29.0
SP 70-11	4.0	5.5		71.5	68.0	66.0	64.0	62.0	60.0	57.0	47.0	32.5
SP 70-13	4.0	5.5		84.0	80.0	78.0	77.0	74.0	71.0	67.0	56.0	38.0
SP 70-15	5.5	7.5		97.5	92.5	90.5	88.5	86.0	82.5	78.5	64.0	44.0
SP 70-17	5.5	7.5		110.0	105.0	102.0	99.0	95.5	92.0	87.5	73.0	51.0
SP 70-18	5.5	7.5		117.0	111.0	108.0	104.0	102.0	97.0	93.0	77.0	54.0
SP 70-20	7.5	10.0		130.0	123.0	120.0	116.5	113.0	108.5	103.0	86.0	59.0
SP 70-23	7.5	10.0		149.5	141.5	137.5	133.5	129.0	124.0	118.0	99.0	69.0
SP 70-25	7.5	10.0		163.0	154.0	149.0	145.0	141.0	135.0	129.0	107.0	75.0

Dimensions and Weights

Pump Type	Motor Dia.	Dimensions (mm)			Net Weight (kg)
		A	B	C	
SP 70-04	4"	440	Rp 2" NPT 2"	98	4.4
SP 70-05	4"	505		98	5.0
SP 70-06	4"	570		98	5.7
SP 70-07	4"	635		98	6.3
SP 70-08	4"	700		98	7.0
SP 70-10	4"	830		98	8.2
SP 70-11	4"	895		98	8.9
SP 70-13	4"	1025		98	10.2
SP 70-15	4"	1155		98	11.5
SP 70-17	4"	1285		98	12.8
SP 70-18	4"	1350		98	13.4
SP 70-20	4"	1480		98	14.7
SP 70-23	4"	1675		98	16.6
SP 70-25	4"	1805		98	17.8

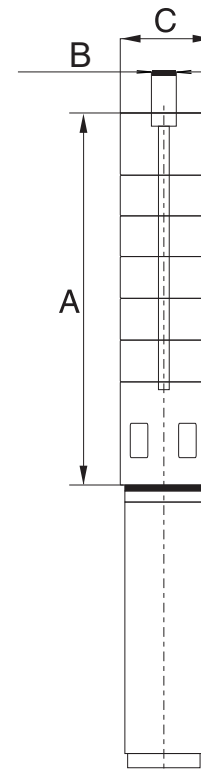

C=Maximum diameter of pump inclusive of cable guard and motor.

Performance Curves

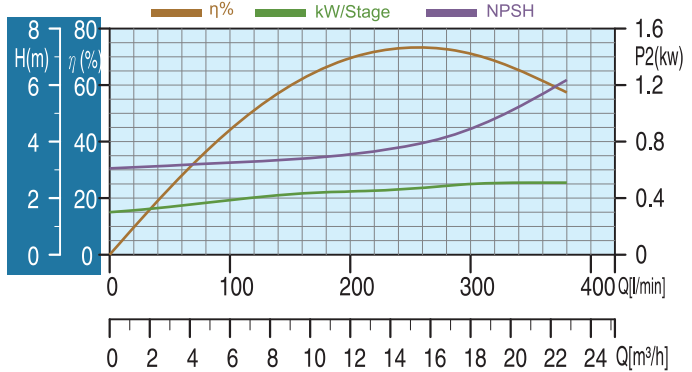
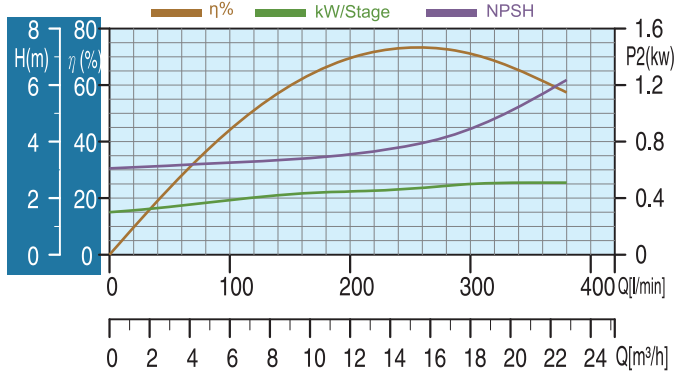
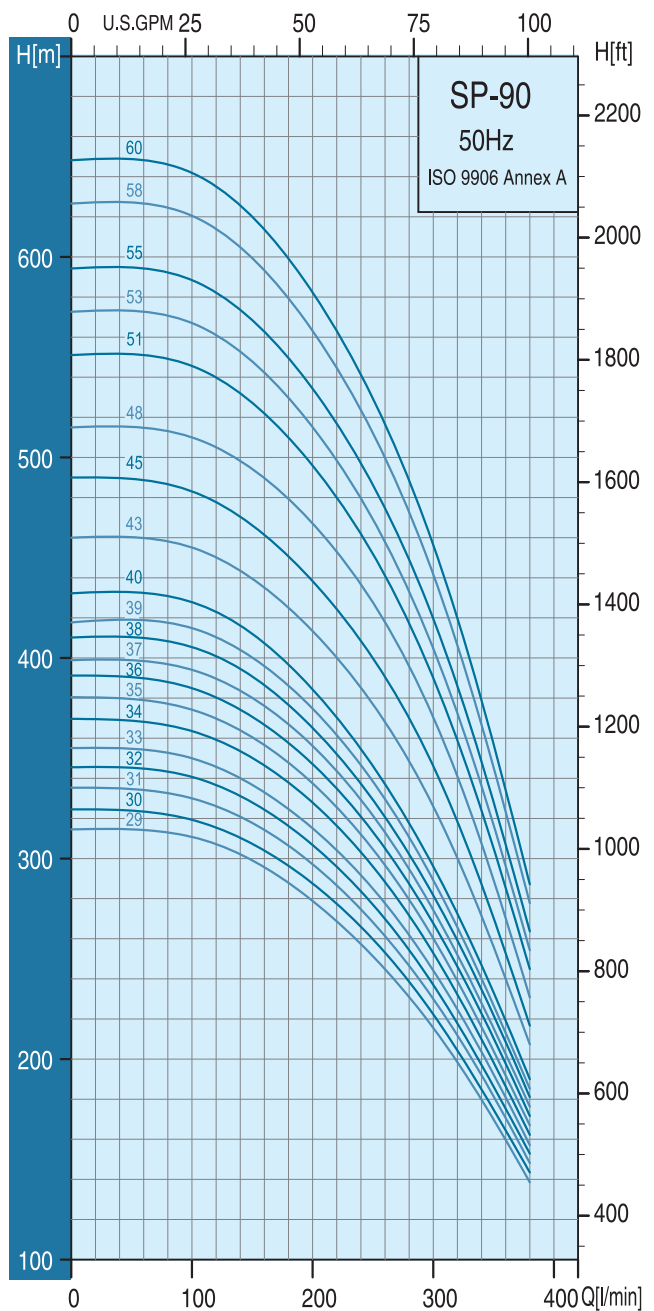
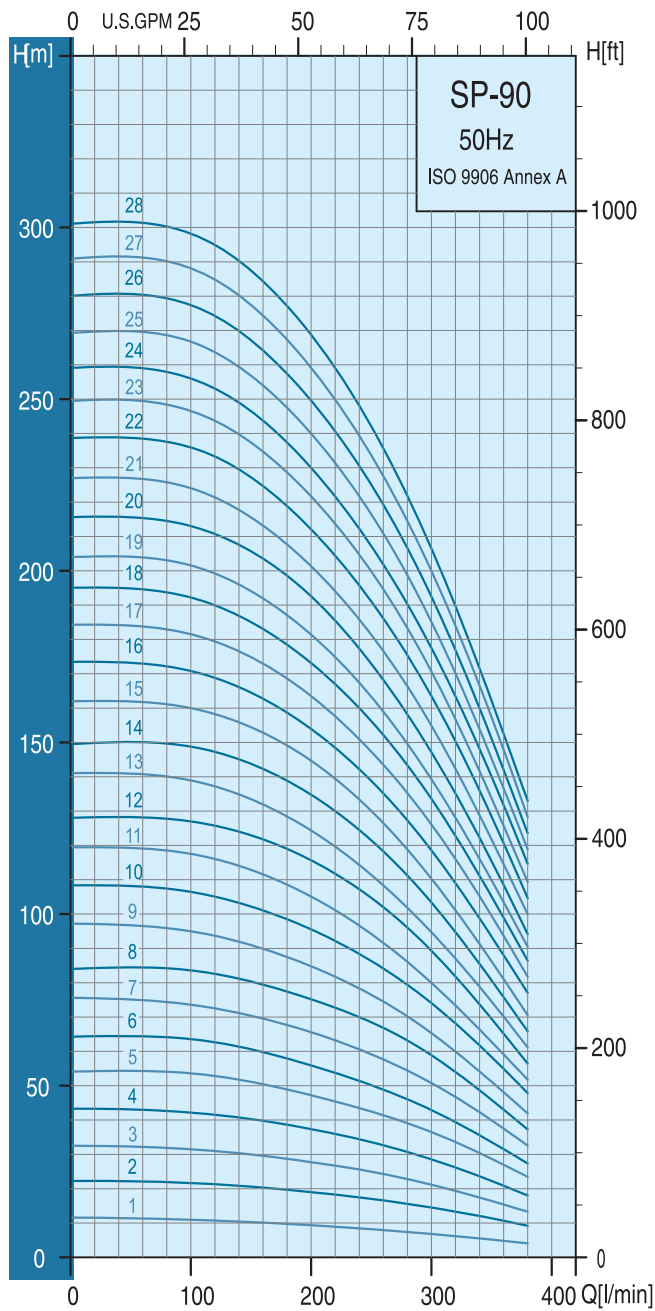

Specifications

Pump Type	Motor		Q=DELIVERY 2850rpm								
	P ₂		l/min	50	100	150	200	250	300	350	383
	kW	HP	m ³ /h	3.0	6.0	9.0	12.0	15.0	18.0	21.0	23.0
SP 90-1	0.6	0.8	H (m)	11.5	11.0	10.5	9.5	8.0	7.0	6.0	4.0
SP 90-2	1.1	1.5		22.0	21.5	20.0	19.0	17.5	14.0	12.0	9.0
SP 90-3	2.2	3.0		32.0	31.5	30.0	27.5	25.0	21.0	16.5	13.0
SP 90-4	2.2	3.0		42.5	42.0	40.0	38.0	33.0	28.5	23.0	18.0
SP 90-5	3.0	4.0		53.0	52.0	50.5	47.5	42.5	37.0	28.5	22.0
SP 90-6	3.7	5.0		64.0	63.0	60.0	56.0	50.0	43.0	34.0	27.0
SP 90-7	4.0	5.5		75.0	74.0	70.0	66.0	59.0	50.5	40.0	32.0
SP 90-8	5.5	7.5		84.5	83.5	80.0	75.0	68.0	59.0	46.0	37.0
SP 90-9	5.5	7.5		96.5	95.0	91.0	85.0	76.5	65.0	51.0	42.0
SP 90-10	5.5	7.5		108.0	107.0	102.0	95.0	86.0	74.0	58.0	48.0
SP 90-11	7.5	10.0		119.0	117.5	113.0	105.0	94.0	80.0	62.5	51.5
SP 90-12	7.5	10.0		128.0	127.0	123.0	115.5	104.5	89.0	69.0	56.5
SP 90-13	7.5	10.0		141.0	139.0	133.0	124.0	112.0	95.0	75.0	60.0
SP 90-14	9.3	12.5		150.0	148.5	143.5	134.5	121.5	103.0	80.5	65.5
SP 90-15	9.3	12.5		162.0	160.0	154.5	144.5	130.0	110.0	86.0	70.5
SP 90-16	9.3	12.5		173.0	170.5	164.5	154.0	139.0	118.5	93.0	77.0
SP 90-17	9.3	12.5		184.0	182.0	175.0	163.0	147.0	126.0	100.0	80.0
SP 90-18	9.3	12.5		194.5	192.0	185.0	173.0	156.0	133.5	105.0	86.0
SP 90-19	11.0	15.0		204.0	201.5	194.0	181.0	163.0	139.0	109.5	90.5
SP 90-20	11.0	15.0		216.0	213.0	206.0	192.0	173.0	147.0	116.0	95.0
SP 90-21	11.0	15.0		227.0	224.0	215.5	201.0	181.5	154.5	121.5	100.0
SP 90-22	13.0	17.5		239.0	237.0	228.0	212.0	190.0	163.0	129.0	105.0
SP 90-23	13.0	17.5		249.5	246.5	237.0	221.5	200.0	170.5	133.5	109.0
SP 90-24	13.0	17.5		260.0	257.0	247.0	230.0	208.0	178.0	140.0	115.0
SP 90-25	15.0	20.0		270.0	260.5	256.5	240.0	216.5	185.0	145.0	119.0
SP 90-26	15.0	20.0		280.5	277.5	267.0	249.5	225.0	192.0	151.0	123.5
SP 90-27	15.0	20.0		291.0	288.0	277.0	259.0	234.0	200.0	158.0	128.0
SP 90-28	18.5	25.0		301.5	298.0	287.5	268.5	242.0	206.5	162.0	133.0

Dimensions and Weights

Pump Type	Motor Dia.	Dimensions (mm)				Net Weight (kg)
		A	B	C*	C**	
SP 90-1	4"	343	Rp 2 1/2"	131	—	5
SP 90-2	4"	403		131	—	6
SP 90-3	4"	464		131	—	8
SP 90-4	4"	524		131	—	9
SP 90-5	4"	566		131	—	11
SP 90-6	4"	626		131	—	12
SP 90-7	4"	687		131	—	14
SP 90-8	4"	747		131	—	15
SP 90-9	4"	808		131	—	17
SP 90-10	4"	867		131	—	18
SP 90-11	6"	948		142	142	19
SP 90-12	6"	1008		142	142	21
SP 90-13	6"	1069		142	142	22
SP 90-14	6"	1129		142	142	24
SP 90-15	6"	1190		142	142	25
SP 90-16	6"	1250		142	142	27
SP 90-17	6"	1311		142	142	28
SP 90-18	6"	1371		142	142	30
SP 90-19	6"	1432		142	142	31
SP 90-20	6"	1492		142	142	33
SP 90-21	6"	1553		142	142	34
SP 90-22	6"	1613		142	142	35
SP 90-23	6"	1674		142	142	37
SP 90-24	6"	1734		142	142	38
SP 90-25	6"	1795		142	142	40
SP 90-26	6"	1855		142	142	41
SP 90-27	6"	1916		142	142	43
SP 90-28	6"	1976		142	142	44

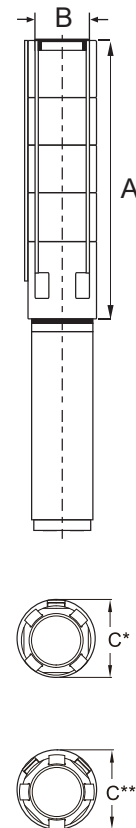

C* : Maximum diameter of pump with one motor cable
 C** : Maximum diameter of pump with two motor cable

Performance Curves

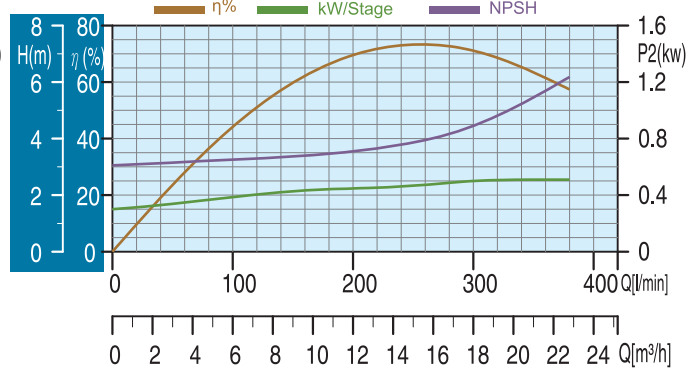
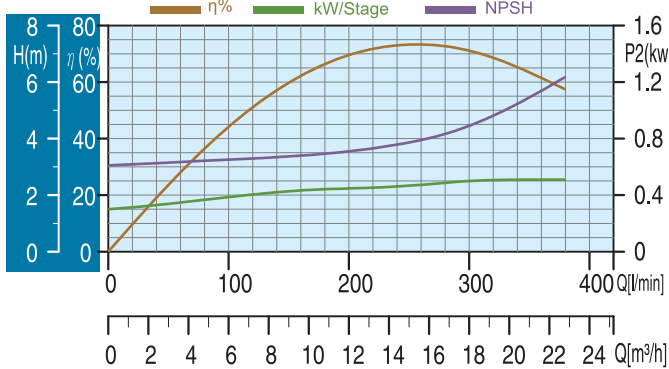
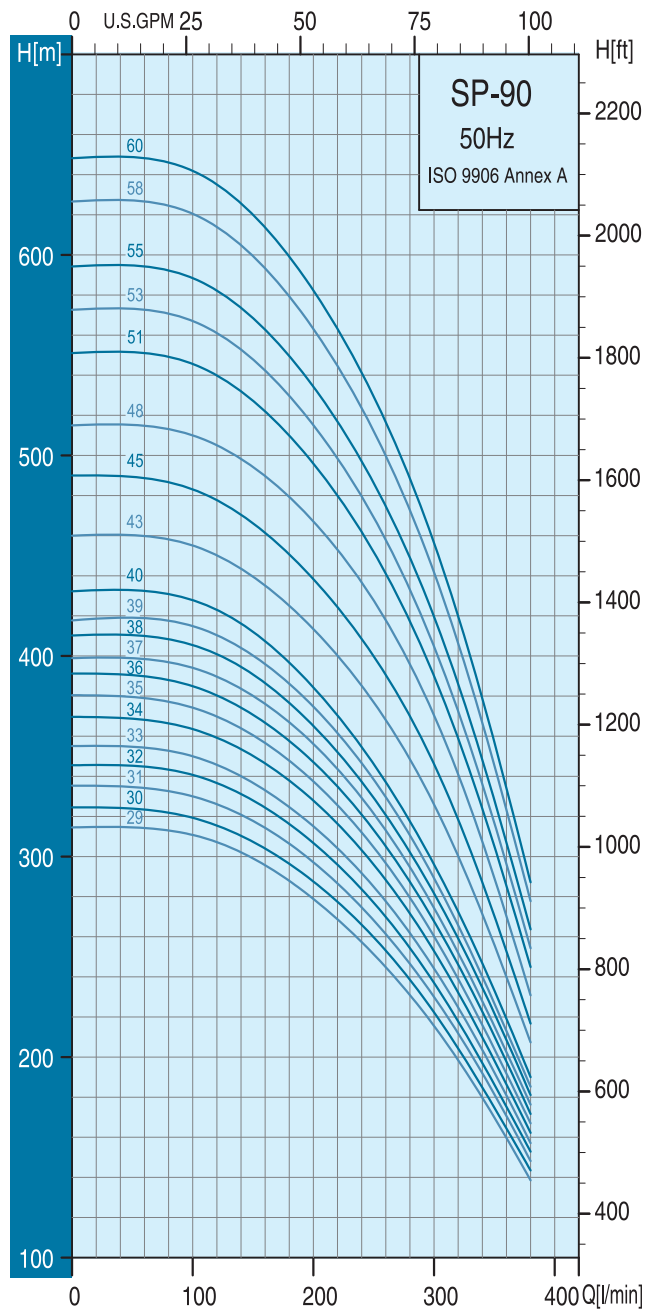
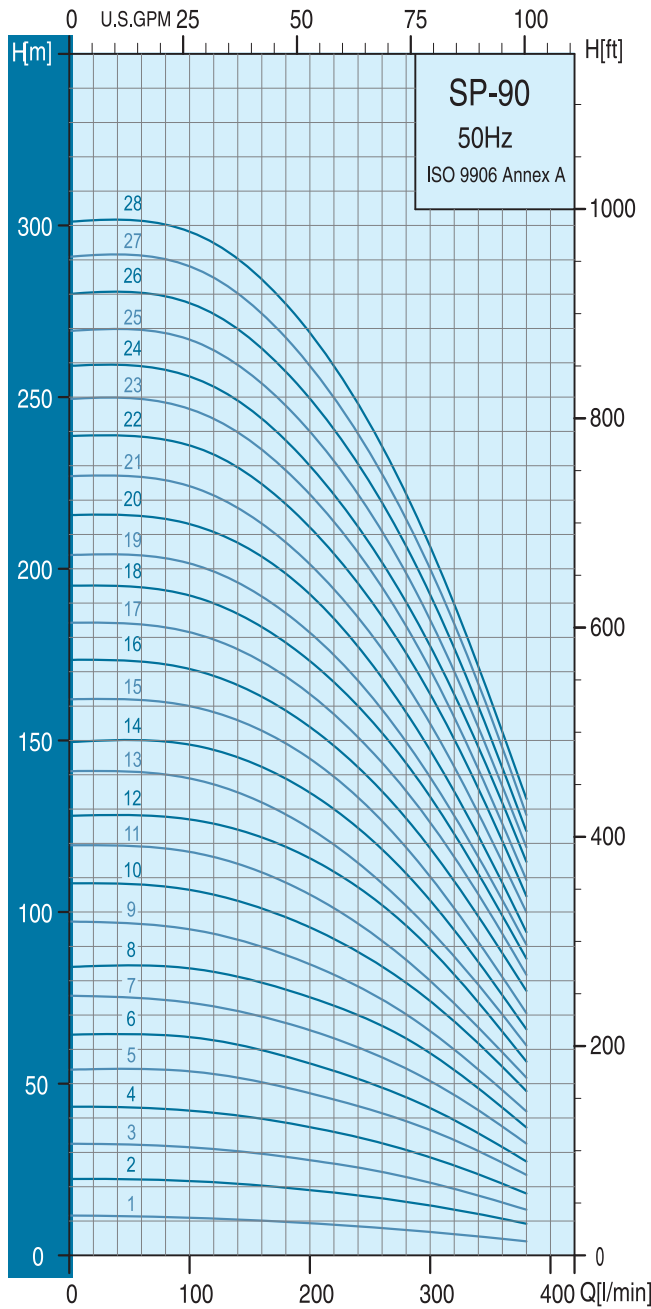

Specifications

Pump Type	Motor		Q=DELIVERY 2850rpm								
	P ₂		l/min	50	100	150	200	250	300	350	383
	kW	HP	m ³ /h	3.0	6.0	9.0	12.0	15.0	18.0	21.0	23.0
SP 90-29	18.5	25.0	H (m)	314.0	311.0	300.0	279.0	250.0	215.0	170.0	138.0
SP 90-30	18.5	25.0		324.0	319.0	307.0	287.5	260.0	222.0	175.0	143.5
SP 90-31	18.5	25.0		335.0	330.0	318.0	298.0	269.0	230.0	181.0	148.0
SP 90-32	18.5	25.0		345.0	340.5	328.0	306.5	277.0	237.0	186.5	153.0
SP 90-33	18.5	25.0		355.0	350.0	337.0	315.0	285.0	243.0	191.0	157.0
SP 90-34	18.5	25.0		368.5	363.5	350.0	327.5	296.0	253.0	198.5	162.0
SP 90-35	22.0	30.0		379.0	374.0	360.5	337.5	304.5	260.0	204.0	167.0
SP 90-36	22.0	30.0		390.0	385.0	371.0	348.0	313.0	268.0	210.0	170.0
SP 90-37	22.0	30.0		399.0	394.0	380.0	356.0	321.5	274.0	202.5	176.0
SP 90-38	22.0	30.0		410.0	405.0	390.0	365.0	330.0	281.0	222.0	180.0
SP 90-39	22.0	30.0		419.0	415.0	400.0	374.5	364.0	289.0	227.0	185.0
SP 90-40	22.0	30.0		433.0	428.0	412.0	384.0	346.0	296.0	235.0	190.0
▶ SP 90-43	26.0	35.0		460.0	455.0	439.5	413.5	377.0	326.0	256.5	207.0
▶ SP 90-45	26.0	35.0		489.0	483.0	466.0	438.0	399.5	346.0	271.0	216.5
▶ SP 90-48	26.0	35.0		515.0	510.0	494.0	467.0	427.5	370.5	290.0	230.5
▶ SP 90-51	30.0	40.0		551.0	545.5	527.0	496.0	451.5	390.0	305.5	245.0
▶ SP 90-53	30.0	40.0		573.0	567.0	548.0	515.0	469.0	405.0	317.0	254.0
▶ SP 90-55	37.0	50.0		594.5	588.5	568.5	534.0	486.0	420.0	328.5	263.5
▶ SP 90-58	37.0	50.0		627.0	620.5	600.0	563.0	512.0	442.0	346.0	277.5
▶ SP 90-60	37.0	50.0		648.5	642.0	620.0	582.0	529.0	456.5	357.0	287.0

*Higher pressure , longer stages pumps up to 60 stages are available on request.

▶ With Sleeve

Dimensions and Weights

Pump Type	Motor Dia.	Dimensions (mm)				Net Weight (kg)	
		A	B	C*	C**		
SP 90-29	6"	2037	Rp 2 1/2"	142	142	46	
SP 90-30	6"	2097		142	142	47	
SP 90-31	6"	2158		142	142	49	
SP 90-32	6"	2218		142	142	50	
SP 90-33	6"	2279		142	142	51	
SP 90-34	6"	2339		142	142	53	
SP 90-35	6"	2400		142	142	54	
SP 90-36	6"	2460		142	142	56	
SP 90-37	6"	2521		142	142	57	
SP 90-38	6"	2581		142	142	59	
SP 90-39	6"	2642		Rp 3" NPT 3"	142	142	60
SP 90-40	6"	2702			142	142	62
▶ SP 90-43	6"	3255			178	181	122
▶ SP 90-45	6"	3376			178	181	126
▶ SP 90-48	6"	3558	178		181	133	
▶ SP 90-51	6"	3739	178		181	139	
▶ SP 90-53	6"	3860	178		181	143	
▶ SP 90-55	6"	3981	178	181	148		
▶ SP 90-58	6"	4163	178	181	154		
▶ SP 90-60	6"	4284	178	181	159		

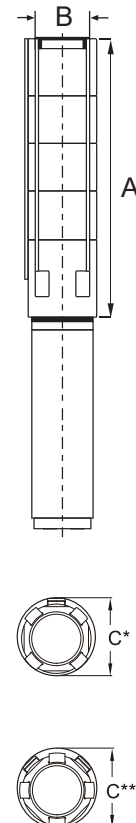

C* : Maximum diameter of pump with one motor cable

C** : Maximum diameter of pump with two motor cable

SP 90-43 to SP 90-60 are mounted in sleeve for R 3 connection

▶ With Sleeve

Performance Curves

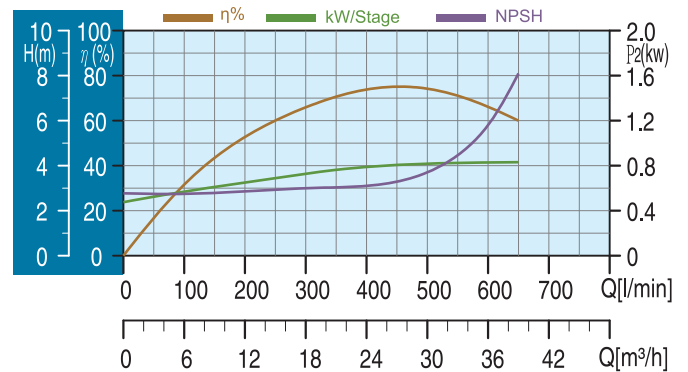
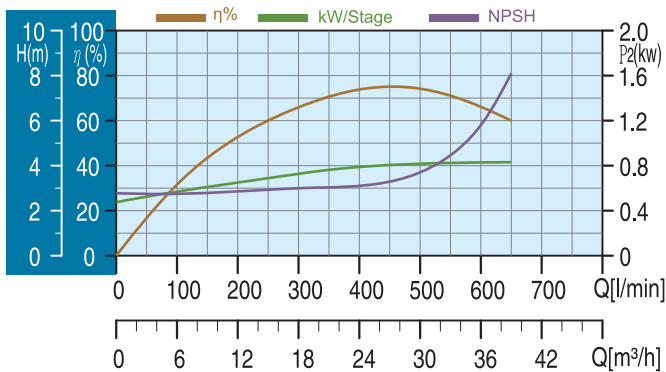
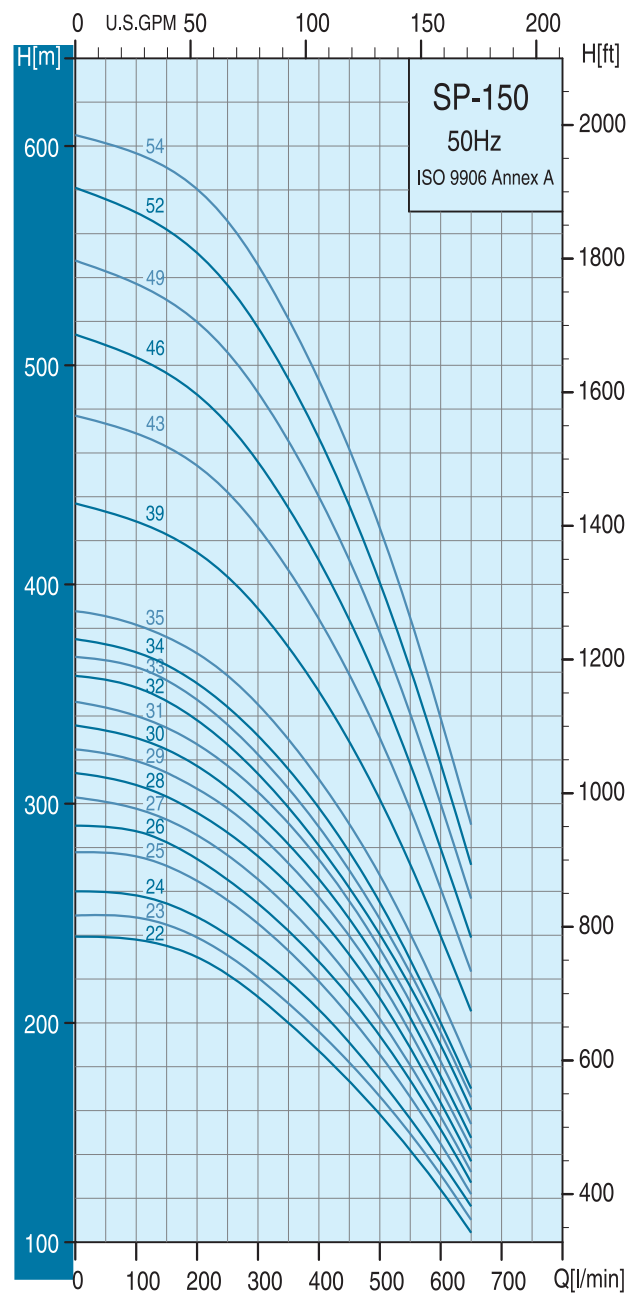
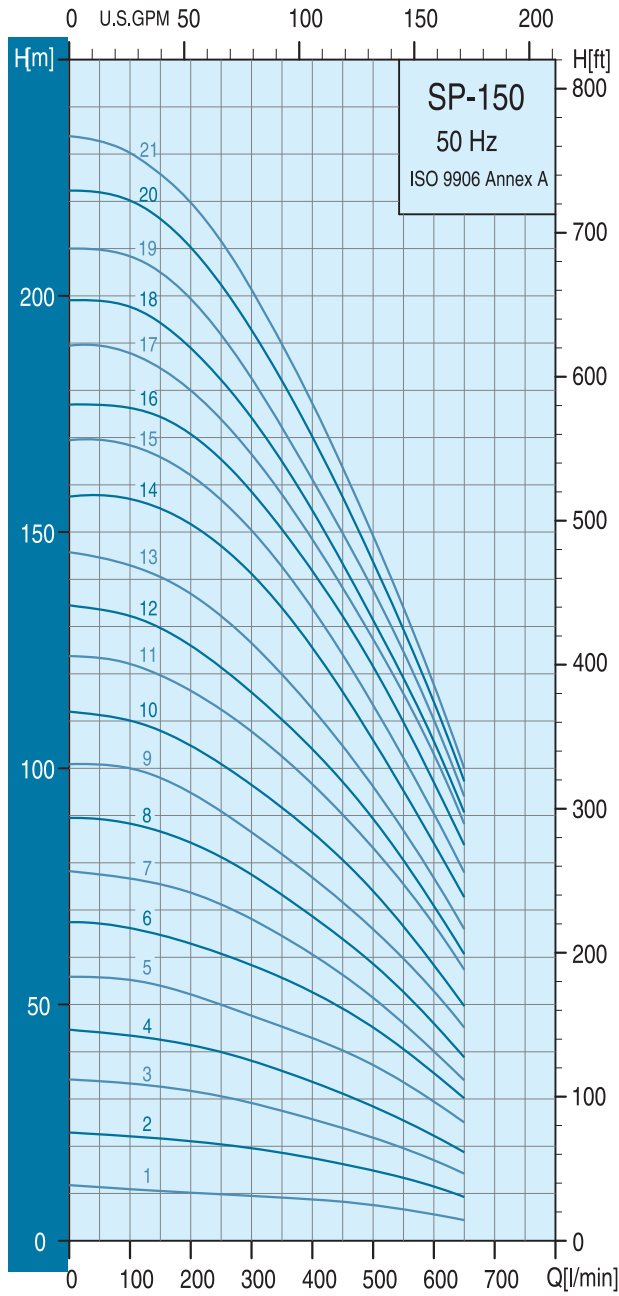

Specifications

Pump Type	Motor		Q=DELIVERY 2850rpm												
	P ₂		l/min	100	150	200	250	300	350	400	450	500	550	600	650
	kW	HP	m ³ /h	6.0	9.0	12.0	15.0	18.0	21.0	24.0	27.0	30.0	33.0	36.0	39.0
SP 150-1	1.1	1.5	H (m)	11.0	10.5	10.0	10.0	9.5	9.0	8.5	8.0	7.5	6.5	5.5	4.5
SP 150-2	2.2	3.0		23.0	22.0	21.0	20.0	19.0	18.0	17.0	16.0	15.0	13.0	11.0	9.0
SP 150-3	3.0	4.0		33.0	32.0	31.0	30.0	29.0	28.0	26.0	24.0	22.0	20.0	17.0	14.0
SP 150-4	3.7	5.0		43.0	42.0	41.0	40.0	38.0	36.0	34.0	31.0	28.0	26.0	23.0	19.0
SP 150-5	5.5	7.5		55.0	54.0	52.0	50.0	47.5	45.0	43.0	40.0	37.0	33.5	29.0	25.0
SP 150-6	5.5	7.5		67.0	64.0	62.0	60.0	58.0	56.0	52.0	49.0	45.0	40.0	36.0	30.0
SP 150-7	7.5	10.0		76.5	75.5	73.5	71.0	68.0	64.5	60.5	56.0	52.0	46.0	40.0	34.0
SP 150-8	7.5	10.0		88.0	87.0	84.0	81.0	78.0	73.0	68.0	64.0	58.0	53.0	46.0	38.0
SP 150-9	9.3	12.5		100.0	98.0	95.0	91.0	86.5	81.5	77.0	71.5	66.0	59.5	52.5	45.0
SP 150-10	9.3	12.5		110.0	108.0	105.0	101.0	96.5	91.5	86.0	80.5	74.0	66.5	58.0	49.5
SP 150-11	11.0	15.0		122.0	120.0	117.0	112.0	108.0	102.0	97.0	90.0	83.0	76.0	67.0	57.0
SP 150-12	11.0	15.0		132.0	129.5	126.0	121.0	116.0	110.0	104.0	97.0	89.0	80.5	70.5	60.5
SP 150-13	11.0	15.0		143.0	140.0	137.0	132.0	127.0	120.0	113.0	105.0	97.0	87.0	77.0	66.0
SP 150-14	13.0	17.5		157.0	155.0	151.5	147.0	141.0	134.0	125.5	116.0	108.0	95.0	84.0	72.5
SP 150-15	15.0	20.0		168.0	166.0	162.0	157.0	150.0	142.0	134.0	124.0	113.0	102.0	90.0	77.0
SP 150-16	15.0	20.0		176.0	174.0	170.5	165.0	158.5	150.5	141.5	132.0	122.0	109.5	97.0	83.5
SP 150-17	15.0	20.0		188.0	185.0	180.0	173.0	167.0	158.0	148.0	138.0	127.0	116.0	103.0	88.0
SP 150-18	18.5	25.0		197.5	194.0	189.0	182.0	174.0	165.0	154.5	143.0	130.0	119.0	105.5	90.0
SP 150-19	18.5	25.0		208.0	205.0	199.0	192.0	182.0	172.0	161.0	150.0	137.0	125.0	110.0	94.0
SP 150-20	18.5	25.0		220.0	216.0	210.0	202.0	193.0	182.0	170.0	157.0	144.0	129.0	114.0	97.0
SP 150-21	18.5	25.0		230.0	226.0	220.0	212.0	202.0	190.0	177.0	164.0	149.0	134.0	117.0	100.0

Dimensions and Weights

Pump Type	Motor Dia.	Dimensions (mm)				Net Weight (kg)
		A	B	C*	C**	
SP 150-1	4"	366	Rp 3" NPT 3"	131	-	6.7
SP 150-2	4"	462		131	-	8.4
SP 150-3	4"	558		131	-	10.1
SP 150-4	4"	654		131	-	11.8
SP 150-5	4"	750		131	-	13.5
SP 150-6	4"	846		131	-	15.2
SP 150-7	6"	942		142	142	16.9
SP 150-8	6"	1038		142	142	18.6
SP 150-9	6"	1134		142	142	20.3
SP 150-10	6"	1230		142	142	22
SP 150-11	6"	1326		142	142	23.6
SP 150-12	6"	1422		142	142	25.3
SP 150-13	6"	1518		142	142	27
SP 150-14	6"	1614		142	142	29.7
SP 150-15	6"	1710		142	142	30.4
SP 150-16	6"	1806		142	142	32.1
SP 150-17	6"	1902		142	142	33.8
SP 150-18	6"	1998		142	142	35.5
SP 150-19	6"	2094		142	142	37.2
SP 150-20	6"	2190		142	142	38.9
SP 150-21	6"	2286		142	142	40.6

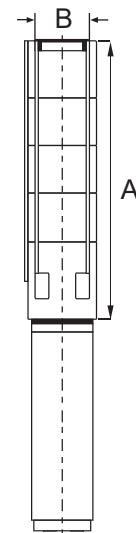

Performance Curves

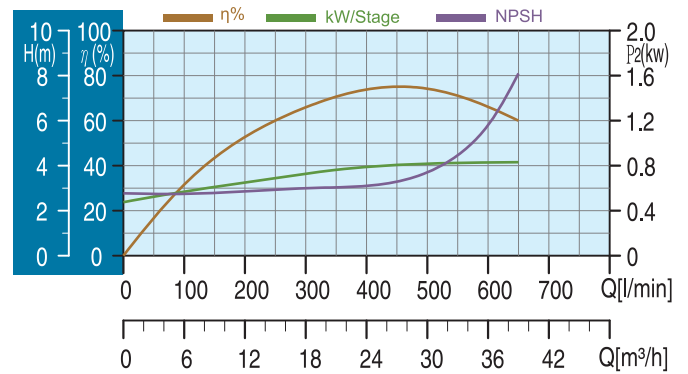
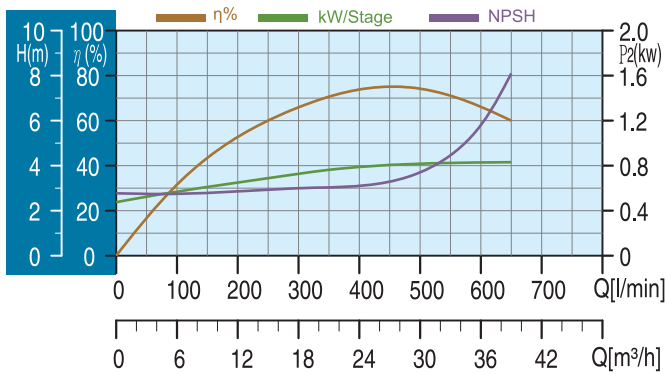
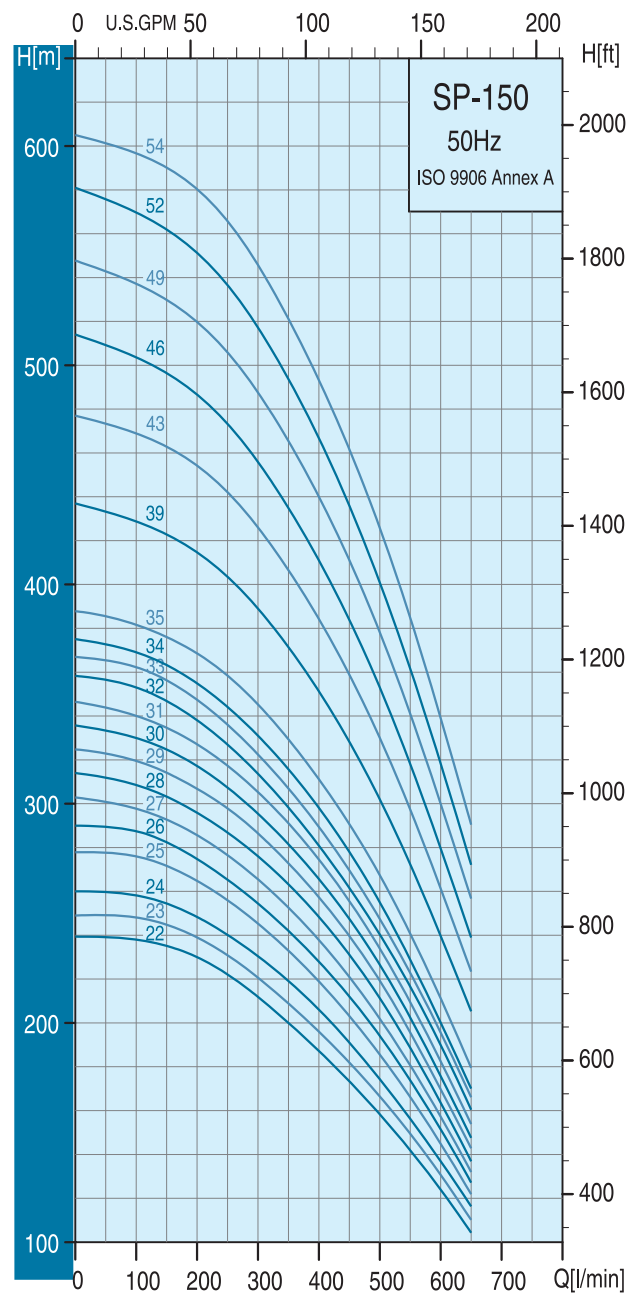
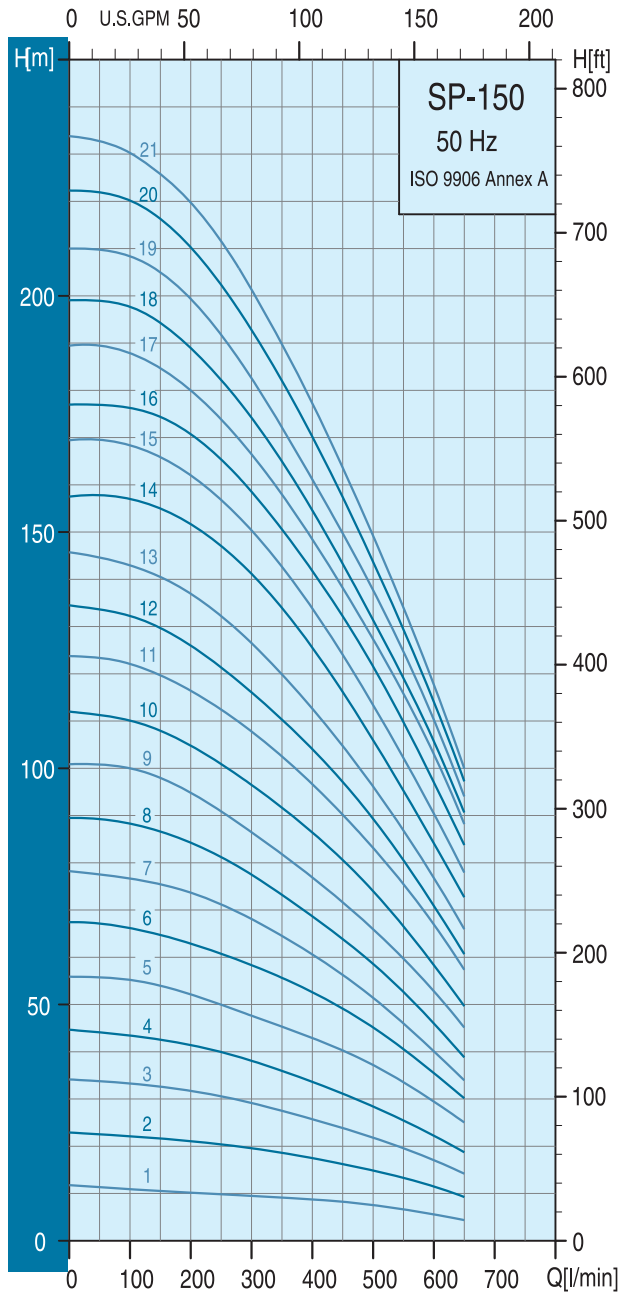

Specifications

Pump Type	Motor		Q=DELIVERY 2850rpm												
	P ₂		l/min	100	150	200	250	300	350	400	450	500	550	600	650
	kW	HP	m ³ /h	6.0	9.0	12.0	15.0	18.0	21.0	24.0	27.0	30.0	33.0	36.0	39.0
SP 150-22	22.0	30.0	H (m)	238.0	235.0	230.0	222.0	212.0	200.0	187.0	173.0	159.0	142.0	123.5	104.0
SP 150-23	22.0	30.0		248.0	244.5	239.0	231.0	220.5	209.0	196.0	182.0	166.5	149.5	130.5	110.0
SP 150-24	22.0	30.0		258.0	254.0	248.0	240.0	230.0	219.0	207.0	191.0	175.0	156.0	137.0	117.0
SP 150-25	22.0	30.0		276.0	271.5	264.5	256.0	245.0	233.0	218.5	203.0	186.5	166.0	144.5	122.0
SP 150-26	22.0	30.0		287.0	282.0	275.0	266.0	255.0	242.0	227.0	212.0	194.0	173.0	152.0	127.0
SP 150-27	26.0	35.0		297.5	292.5	285.5	276.5	265.0	252.5	237.5	221.0	202.0	180.5	157.0	132.0
SP 150-28	26.0	35.0		308.5	303.0	296.0	287.0	276.0	263.0	248.0	231.0	212.0	188.5	163.5	136.5
SP 150-29	26.0	35.0		319.0	314.0	307.0	298.0	287.0	273.0	257.0	240.0	220.0	196.0	170.0	143.0
SP 150-30	26.0	35.0		330.0	324.5	317.0	307.0	295.0	281.5	265.5	247.5	226.5	202.0	175.5	147.5
SP 150-31	26.0	35.0		340.0	334.5	327.0	317.0	305.0	291.0	274.5	255.5	234.0	209.0	182.5	153.5
SP 150-32	30.0	40.0		353.0	347.0	338.0	327.0	313.0	298.0	281.0	261.0	240.0	217.0	190.0	160.0
SP 150-33	30.0	40.0		362.0	356.0	347.0	336.0	322.0	307.0	289.0	269.5	247.5	222.5	195.5	166.0
SP 150-34	30.0	40.0		369.0	363.0	355.0	344.0	331.0	315.5	298.0	278.0	255.0	229.0	200.0	170.0
SP 150-35	30.0	40.0		382.0	377.0	368.0	358.0	346.0	329.0	311.0	290.0	267.0	240.0	211.0	180.0
SP 150-39	37.0	50.0		428.5	422.5	415.0	403.5	389.0	371.0	351.0	328.0	302.0	272.0	240.0	205.0
SP 150-43	37.0	50.0		468.5	462.5	454.0	442.0	426.0	406.5	384.0	358.5	330.0	297.0	261.0	223.0
SP 150-46	45.0	60.0		503.0	496.0	486.5	473.0	456.0	435.0	411.0	383.5	353.0	318.0	279.5	239.0
SP 150-49	45.0	60.0		537.0	529.5	520.0	506.0	487.5	465.0	440.0	411.0	378.0	341.0	300.0	256.5
SP 150-52	55.0	75.0		569.0	561.5	551.0	536.5	517.0	493.5	466.5	436.0	401.0	361.5	318.0	272.0
SP 150-54	55.0	75.0		596.0	590.0	580.0	566.0	546.0	521.0	493.0	461.5	428.0	384.5	339.0	290.0

*Higher pressure , longer stages pumps up to 54 stages are available on request.

▶With Sleeve

Dimensions and Weights

Pump Type	Motor Dia.	Dimensions (mm)				Net Weight (kg)
		A	B	C*	C**	
SP 150-22	6"	2382	Rp 3" NPT 3"	142	142	42.3
SP 150-23	6"	2478		142	142	44.0
SP 150-24	6"	2574		142	142	45.6
SP 150-25	6"	2670		142	142	47.3
SP 150-26	6"	2766		142	142	49.0
SP 150-27	6"	2862		142	142	50.7
SP 150-28	6"	2958		142	142	52.4
SP 150-29	6"	3054		142	142	54.1
SP 150-30	6"	3150		142	142	55.8
SP 150-31	6"	3246		142	142	57.5
SP 150-32	6"	3342		142	142	59.2
SP 150-33	6"	3438		142	142	60.9
SP 150-34	6"	3534		142	142	62.6
SP 150-35	6"	3630		142	142	64.3
SP 150-39	6"	4451		178	181	142.0
SP 150-43	6"	4775		178	181	151.2
SP 150-46	8"	5016		192	192	190.8
SP 150-49	8"	5304		192	192	198.1
SP 150-52	8"	5592		192	192	213.5
SP 150-54	8"	5784		192	192	220.0

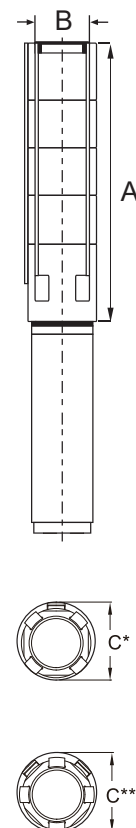

C* : Maximum diameter of pump with one motor cable

C** : Maximum diameter of pump with two motor cable

SP 150-39 to SP 150-54 are mounted in sleeve for R 3 connection

▶With Sleeve

Performance Curves

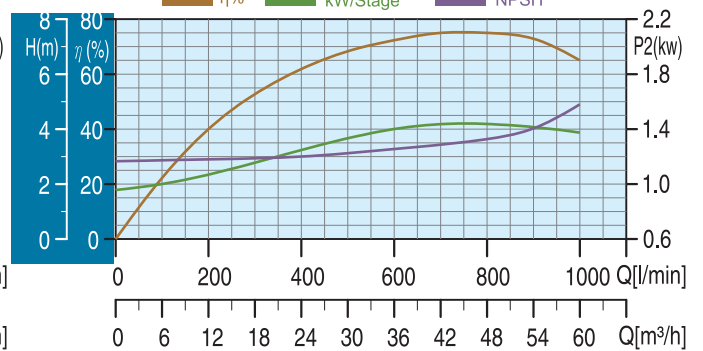
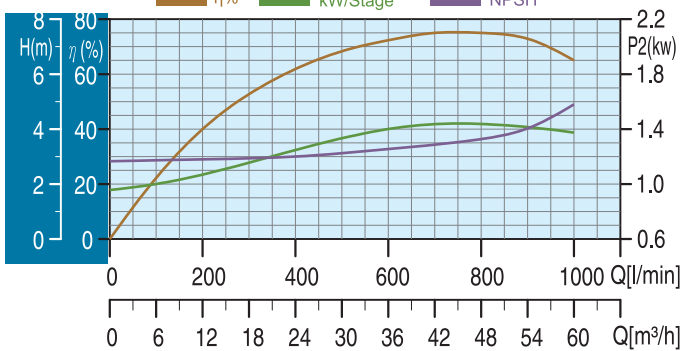
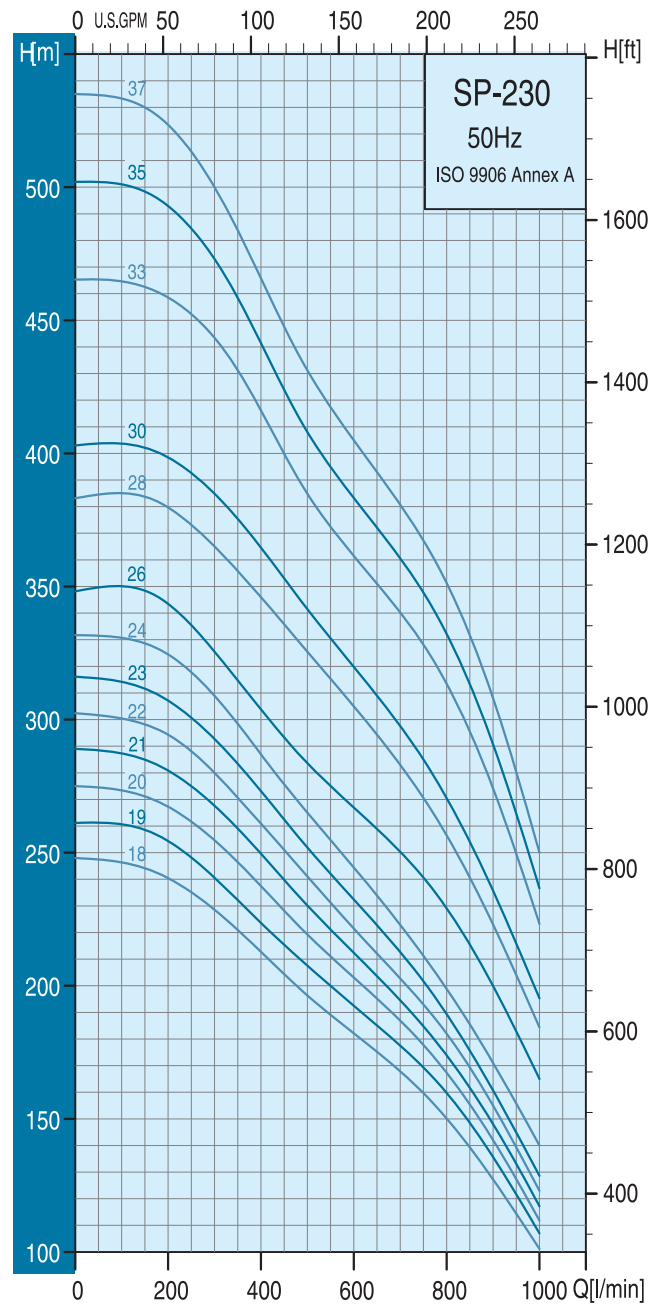
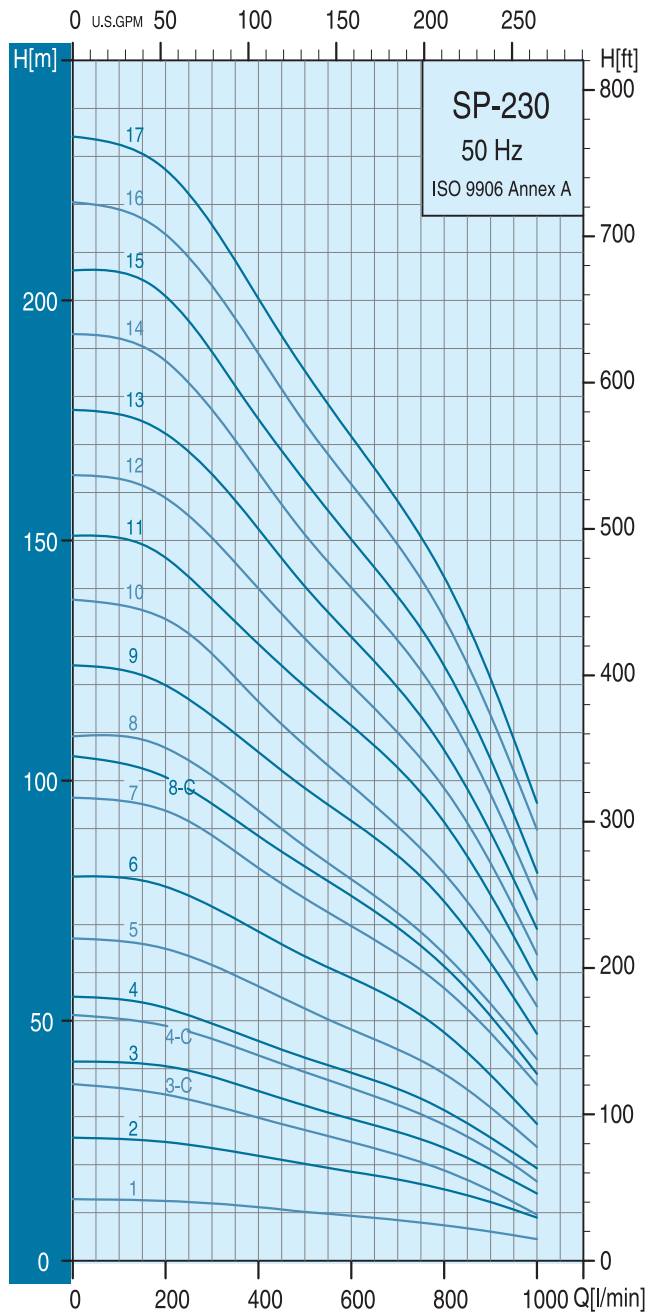

Specifications

Pump Type	Motor		Q=DELIVERY 2850rpm												
	P ₂		l/min	200	250	300	350	400	450	500	600	700	800	900	1000
	kW	HP	m ³ /h	12.0	15.0	18.0	21.0	24.0	27.0	30.0	36.0	42.0	48.0	54.0	60.0
SP 230-1	2.2	3.0	H (m)	12.5	12.5	12.0	11.5	11.0	10.5	10.0	9.0	8.5	7.5	6.0	4.5
SP 230-2	3.0	4.0		24.0	23.5	23.0	22.5	22.0	21.0	20.0	18.0	17.0	15.0	12.0	9.0
SP 230-3C	3.7	5.0		35.0	34.0	32.0	31.0	29.0	28.0	27.0	24.0	22.0	19.0	14.0	10.0
SP 230-3	5.5	7.5		40.0	39.0	38.0	37.0	35.0	34.0	33.0	29.0	27.0	23.0	18.0	24.0
SP 230-4C	5.5	7.5		49.0	47.0	46.0	45.0	43.0	41.0	39.0	36.0	32.0	28.0	23.0	17.0
SP 230-4	7.5	10.0		52.5	51.0	49.0	47.5	45.5	44.0	42.0	39.0	36.0	31.0	25.5	19.0
SP 230-5	7.5	10.0		65.0	63.0	61.0	59.0	57.0	55.0	53.0	48.0	44.0	39.0	32.0	24.0
SP 230-6	9.3	12.5		78.0	76.0	73.5	71.0	68.5	66.0	63.0	59.0	54.0	47.5	38.5	28.5
SP 230-7	11.0	15.0		94.0	92.0	88.0	85.0	82.0	79.0	76.0	70.0	64.0	57.0	47.0	37.0
SP 230-8C	11.0	15.0		100.0	98.0	95.0	92.0	88.0	85.0	82.0	76.0	69.0	61.0	51.0	39.0
SP 230-8	13.0	17.5		106.5	104.0	101.0	97.0	93.5	90.0	86.0	79.0	72.5	64.0	53.5	42.0
SP 230-9	15.0	20.0		120.0	117.0	113.5	109.5	106.0	102.0	98.0	91.5	84.5	74.5	61.5	47.0
SP 230-10	15.0	20.0		133.0	130.0	127.0	122.0	117.0	112.0	107.0	98.0	90.0	80.0	67.0	53.0
SP 230-11	18.5	25.0		146.0	142.0	138.0	133.0	128.0	124.0	119.5	111.5	103.0	91.0	76.0	58.5
SP 230-12	18.5	25.0		158.0	155.0	150.0	145.0	140.0	135.0	130.0	120.0	110.0	98.0	83.0	64.0
SP 230-13	22.0	30.0		172.0	168.5	164.0	158.0	152.0	146.0	140.0	130.0	119.5	106.0	88.5	69.0
SP 230-14	22.0	30.0		187.0	183.0	177.0	171.0	164.0	157.5	151.0	140.0	129.0	115.0	96.5	75.0
SP 230-15	22.0	30.0	200.0	195.0	189.0	183.0	176.0	169.0	163.0	150.0	138.0	124.0	103.0	81.0	
SP 230-16	26.0	35.0	213.5	209.0	203.0	196.0	189.0	181.5	174.0	161.5	149.0	133.5	113.0	90.0	
SP 230-17	26.0	35.0	227.0	222.0	215.0	208.0	200.0	193.0	186.0	172.0	158.0	143.0	121.0	96.0	

Dimensions and Weights

Pump Type	Motor Dia.	Dimensions (mm)				Net Weight (kg)	
		A	B	C*	C**		
SP 230-1	4"	383	Rp 3" NPT 3"	146	-	6.9	
SP 230-2	4"	496		146	-	9.2	
SP 230-3C	4"	609		146	-	11.5	
SP 230-3	4"	609		146	-	11.5	
SP 230-4C	4"	722		146	-	13.8	
SP 230-4	6"	722		149	152	13.8	
SP 230-5	6"	835		149	152	16.0	
SP 230-6	6"	948		149	152	18.3	
SP 230-7	6"	1061		149	152	20.6	
SP 230-8C	6"	1174		149	152	22.9	
SP 230-8	6"	1174		Rp 4" NPT 4"	149	152	22.9
SP 230-9	6"	1287			149	152	25.2
SP 230-10	6"	1400			149	152	27.4
SP 230-11	6"	1513			149	152	29.7
SP 230-12	6"	1626			149	152	32.0
SP 230-13	6"	1739			149	152	34.3
SP 230-14	6"	1852			149	152	36.6
SP 230-15	6"	1965	149		152	38.8	
SP 230-16	6"	2078	149	152	41.1		
SP 230-17	6"	2191	149	152	43.4		

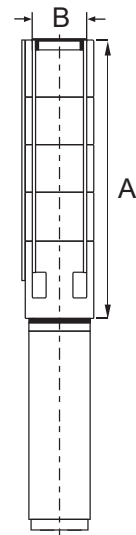

Performance Curves

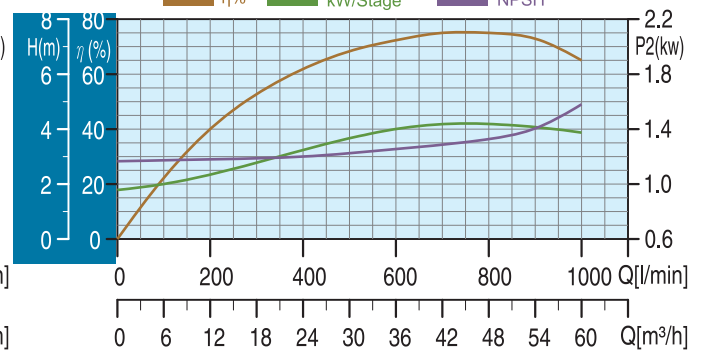
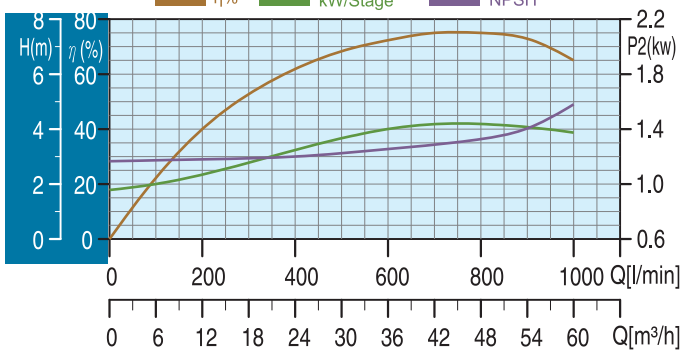
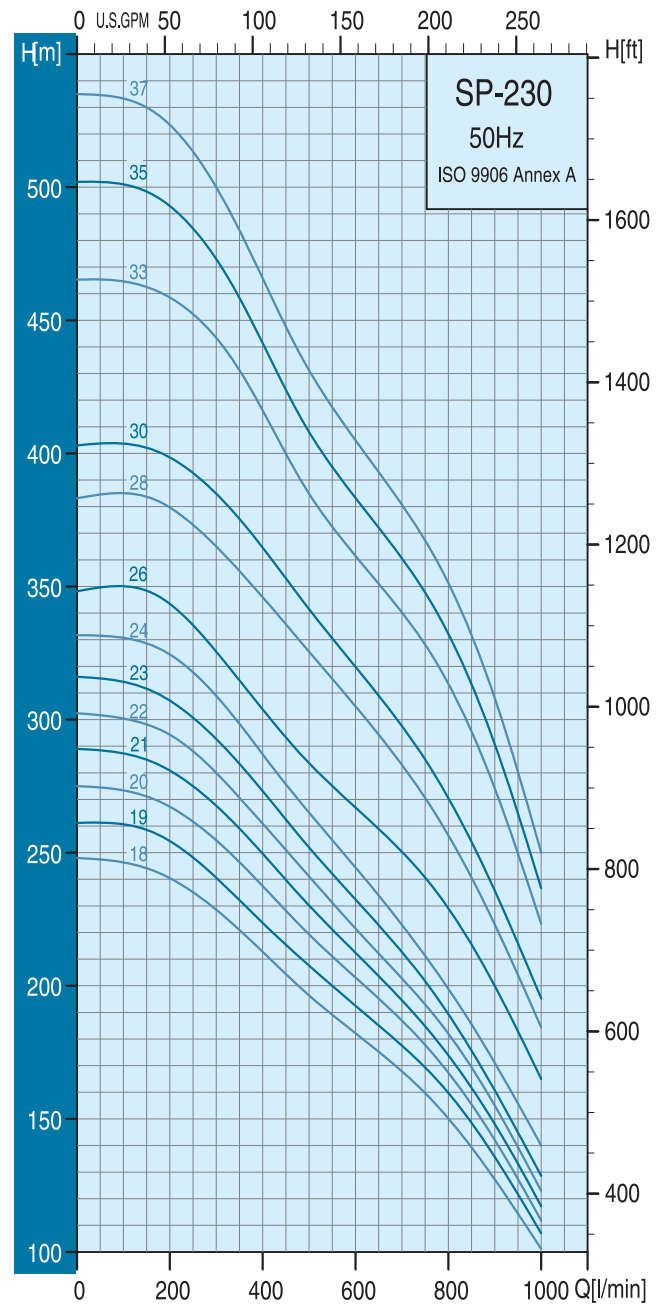
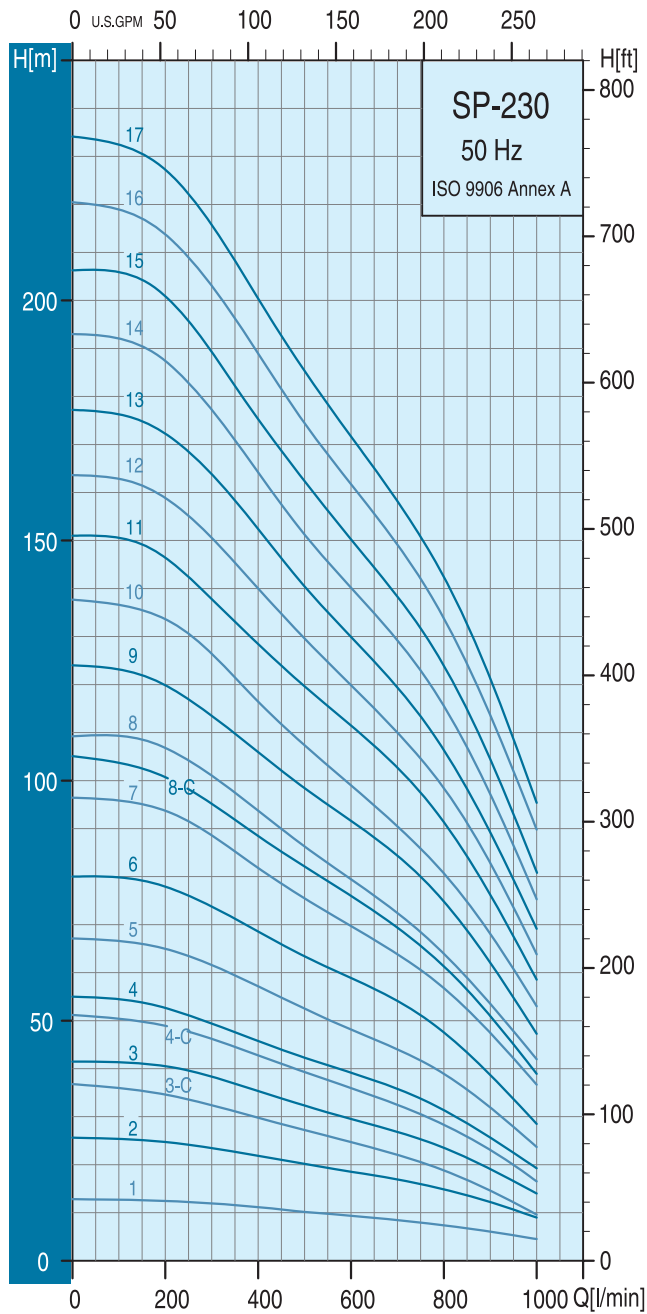

Specifications

Pump Type	Motor		Q=DELIVERY 2850rpm												
	P ₂		l/min	200	250	300	350	400	450	500	600	700	800	900	1000
	kW	HP	m ³ /h	12.0	15.0	18.0	21.0	24.0	27.0	30.0	36.0	42.0	48.0	54.0	60.0
SP 230-18	30.0	40.0	H (m)	240.0	235.0	228.5	221.0	212.5	204.0	196.0	182.0	168.0	150.0	127.0	101.0
SP 230-19	30.0	40.0		254.0	248.0	241.0	233.0	224.0	216.0	208.0	193.0	178.0	160.0	136.0	107.0
SP 230-20	30.0	40.0		267.0	261.5	254.5	246.0	237.5	228.0	219.0	203.0	187.0	167.0	142.0	111.5
SP 230-21	37.0	50.0		280.0	275.0	267.5	259.0	249.5	239.5	230.0	212.0	194.5	174.0	148.0	117.0
SP 230-22	37.0	50.0		294.0	288.0	280.0	270.0	260.0	251.0	241.0	222.0	203.0	183.0	155.0	123.0
SP 230-23	37.0	50.0		307.0	300.5	292.5	283.0	273.0	262.0	252.0	232.0	212.5	189.0	160.5	128.5
SP 230-24	37.0	50.0		325.0	317.0	309.0	298.0	287.0	276.0	265.0	244.0	223.0	199.0	171.0	140.0
▶ SP 230-26	45.0	60.0		343.0	334.5	324.0	313.0	302.0	292.0	283.0	267.0	251.0	229.5	200.0	165.0
▶ SP 230-28	45.0	60.0		379.5	373.0	365.0	356.0	346.0	336.0	325.5	305.0	283.0	256.5	223.0	184.0
▶ SP 230-30	45.0	60.0		398.0	392.5	385.0	375.0	364.5	353.0	341.5	320.0	297.5	270.5	235.5	195.0
▶ SP 230-33	55.0	75.0		458.5	452.0	443.0	431.0	416.0	400.0	385.0	361.5	340.0	313.0	274.0	223.0
▶ SP 230-35	55.0	75.0		493.0	484.5	473.0	458.5	441.0	424.0	408.0	383.0	360.5	332.0	290.5	236.5
▶ SP 230-37	63.0	85.0		523.0	513.0	500.0	484.0	466.0	447.5	431.0	405.0	381.0	351.0	308.0	250.0

*Higher pressure , longer stages pumps up to 37 stages are available on request.
 ▶With Sleeve

Dimensions and Weights

Pump Type	Motor Dia.	Dimensions (mm)				Net Weight (kg)
		A	B	C*	C**	
SP 230-18	6"	2304	Rp 3" NPT 3"	149	152	45.7
SP 230-19	6"	2417		149	152	47.9
SP 230-20	6"	2530		149	152	50.2
SP 230-21	6"	2643		149	152	52.5
SP 230-22	6"	2756		149	152	54.8
SP 230-23	6"	2869		149	152	57.1
SP 230-24	6"	2982		149	152	59.3
▶ SP 230-26	8"	2537	Rp 4" NPT 4"	192	192	130.4
▶ SP 230-28	8"	3763	192	192	137.9	
▶ SP 230-30	8"	3989	192	192	146.0	
▶ SP 230-33	8"	4328	192	192	158.4	
▶ SP 230-35	8"	4554	192	192	166.2	
▶ SP 230-37	8"	4780	192	192	174.0	

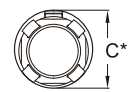
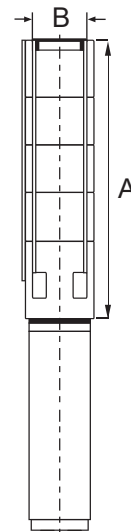

C* : Maximum diameter of pump with one motor cable
 C** : Maximum diameter of pump with two motor cable
 SP 230-26 to SP 230-37 are mounted in sleeve for R 4 connection
 ▶With Sleeve

Performance Curves

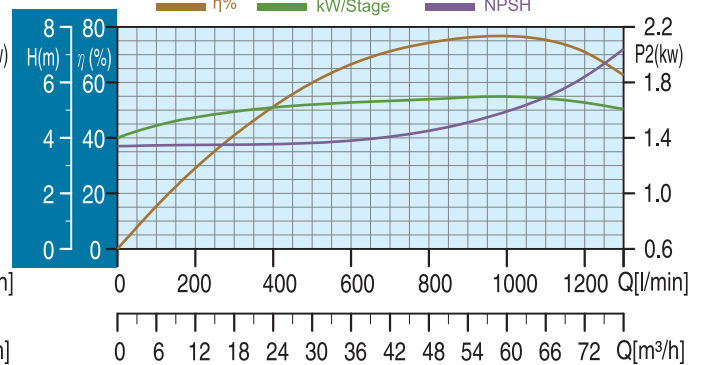
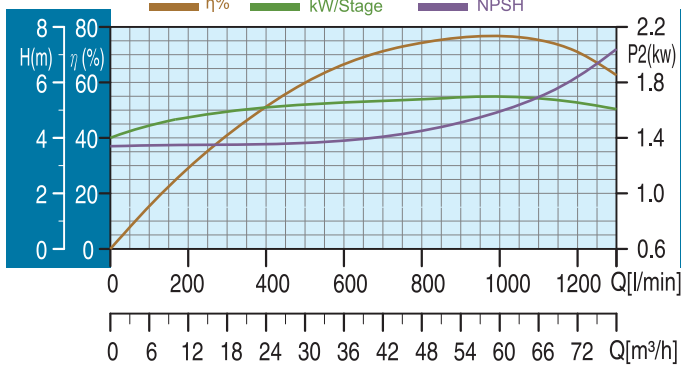
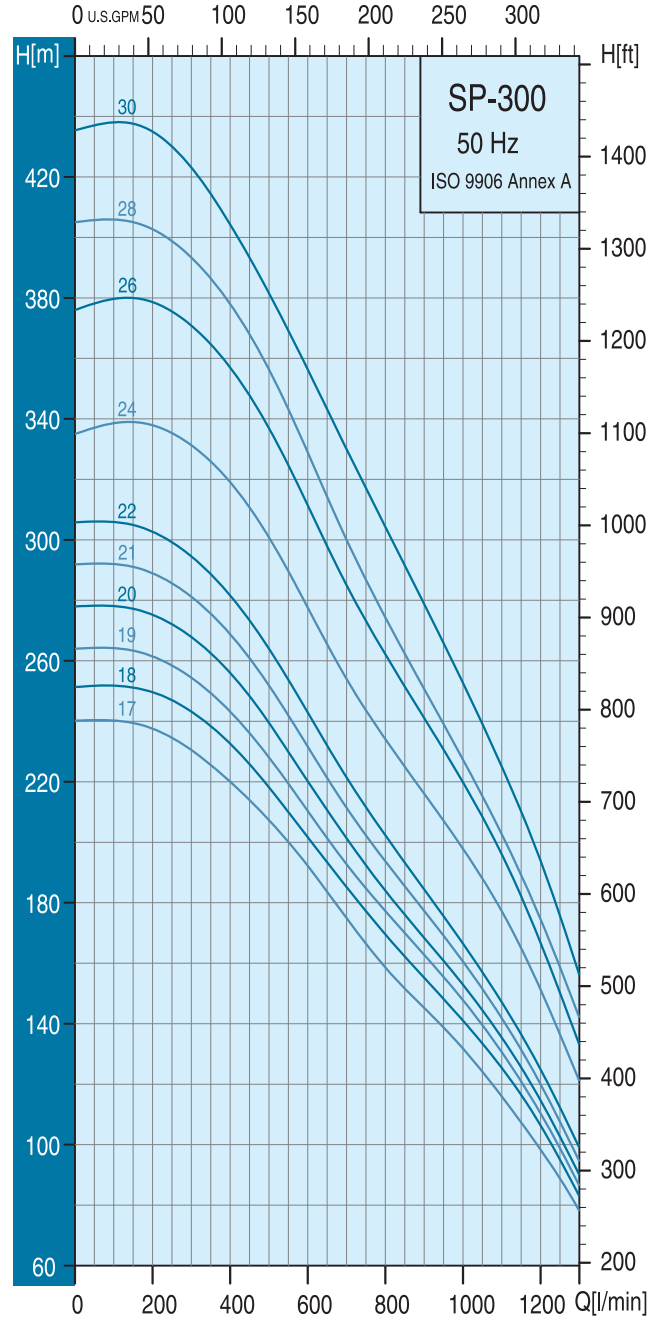
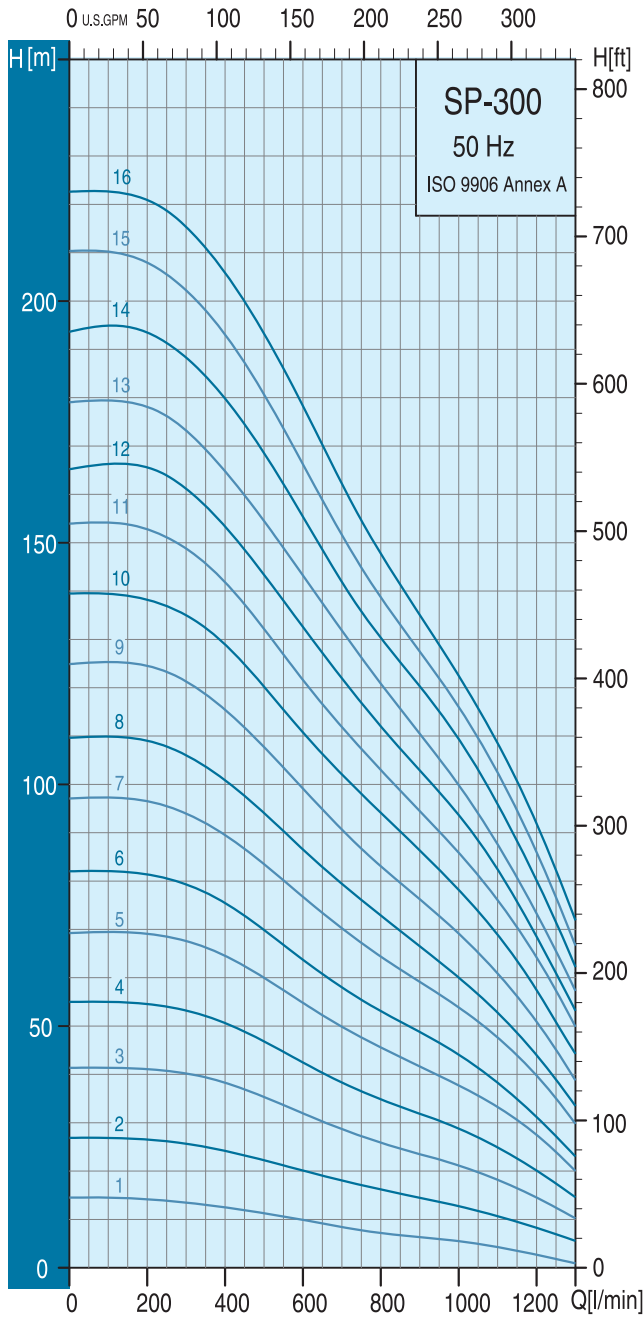

Specifications

Pump Type	Motor		Q=DELIVERY 2850rpm													
	P ₂		l/min	300	350	400	450	500	600	700	800	900	1000	1100	1200	1300
	kW	HP	m ³ /h	18.0	21.0	24.0	27.0	30.0	36.0	42.0	48.0	54.0	60.0	66.0	72.0	78.0
SP 300-1	2.2	3.0	H (m)	13.0	12.5	12.0	11.5	11.0	10.0	8.0	7.0	6.0	5.0	4.0	2.0	1.0
SP 300-2	3.7	5.0		26.0	25.0	24.0	23.0	22.0	20.0	18.0	16.0	14.0	13.0	11.0	8.0	5.0
SP 300-3	5.5	7.5		40.0	39.0	38.0	37.0	36.0	32.0	28.0	26.0	24.0	21.0	18.0	14.0	10.0
SP 300-4	7.5	10.0		53.0	52.0	51.0	48.0	47.0	43.0	38.0	35.0	32.0	28.0	25.0	20.0	14.0
SP 300-5	9.3	12.5		67.0	66.0	64.0	52.0	60.0	55.0	50.0	46.0	42.0	38.0	33.0	27.0	19.0
SP 300-6	11.0	15.0		79.0	78.0	76.0	73.0	70.0	64.0	58.0	53.0	48.0	44.0	38.0	32.0	23.0
SP 300-7	13.0	17.5		94.0	92.0	89.0	86.0	84.0	77.0	70.0	64.0	59.0	54.0	47.0	40.0	29.0
SP 300-8	15.0	20.0		106.0	104.0	101.0	97.0	94.0	87.0	80.0	73.0	67.0	60.0	53.0	44.0	33.0
SP 300-9	18.5	25.0		122.0	118.0	116.0	112.0	108.0	99.0	91.0	83.0	76.0	69.0	61.0	51.0	38.0
SP 300-10	18.5	25.0		135.0	132.0	128.0	125.0	120.0	111.0	102.0	95.0	87.0	78.0	68.0	57.0	45.0
SP 300-11	22.0	30.0		148.0	146.0	142.0	137.0	132.0	122.0	112.0	103.0	95.0	86.0	76.0	64.0	49.0
SP 300-12	22.0	30.0		162.0	157.0	153.0	148.0	143.0	133.0	122.0	112.0	103.0	94.0	83.0	68.0	53.0
SP 300-13	26.0	35.0		173.0	169.0	165.0	160.0	155.0	143.0	132.0	121.0	110.0	100.0	87.0	73.0	57.0
SP 300-14	26.0	35.0		188.0	184.0	180.0	175.0	168.0	156.0	142.0	130.0	120.0	109.0	96.0	80.0	63.0
SP 300-15	26.0	35.0		203.0	197.0	193.0	187.0	180.0	166.0	152.0	138.0	127.0	116.0	103.0	86.0	67.0
SP 300-16	30.0	40.0		216.0	211.0	206.0	200.0	193.0	178.0	162.0	148.0	135.0	123.0	108.0	92.0	72.0
SP 300-17	37.0	50.0		230.0	226.0	220.0	214.0	207.0	192.0	175.0	158.0	145.0	132.0	116.0	97.0	78.0
SP 300-18	37.0	50.0		243.0	238.0	233.0	226.0	218.0	202.0	185.0	170.0	155.0	141.0	126.0	107.0	83.0
SP 300-19	37.0	50.0		254.0	249.0	243.0	236.0	228.0	210.0	193.0	177.0	162.5	148.0	130.5	110.0	86.0
SP 300-20	37.0	50.0		267.0	263.0	256.0	248.0	239.0	220.0	201.0	184.0	168.0	153.0	136.0	115.0	90.0
SP 300-21	37.0	50.0		281.0	275.5	269.0	261.0	252.0	231.5	211.0	193.5	177.0	161.0	142.0	120.0	94.5
SP 300-22	37.0	50.0		294.5	288.5	281.5	273.0	264.0	243.0	221.0	202.0	184.0	166.5	147.0	125.0	99.0
SP 300-24	45.0	60.0		331.0	325.5	319.0	311.0	301.0	277.5	254.0	234.0	216.0	197.5	177.0	151.0	121.0
SP 300-26	55.0	75.0		371.0	364.5	357.0	348.0	337.0	311.5	285.0	262.0	241.0	220.0	196.0	167.0	133.0
SP 300-28	55.0	75.0		393.0	386.0	378.0	368.0	356.5	329.0	300.0	274.0	250.5	227.0	202.5	174.5	142.0
SP 300-30	55.0	75.0		423.0	414.5	404.0	393.0	381.0	356.0	330.0	304.0	279.0	253.0	225.0	194.0	156.0

*Higher pressure , longer stages pumps up to 30 stages are available on request.

▶ With Sleeve

Dimensions and Weights

Pump Type	Motor Dia.	Dimensions (mm)				Net Weight (kg)
		A	B	C*	C**	
SP 300-1	4"	383	Rp 3" NPT 3"	146	-	6.9
SP 300-2	4"	496		146	-	9.2
SP 300-3	4"	609		146	-	11.5
SP 300-4	6"	722		149	152	13.7
SP 300-5	6"	835		149	152	16.0
SP 300-6	6"	948		149	152	18.3
SP 300-7	6"	1061		149	152	20.6
SP 300-8	6"	1174		149	152	22.9
SP 300-9	6"	1287		149	152	25.1
SP 300-10	6"	1400		149	152	27.4
SP 300-11	6"	1513		149	152	29.7
SP 300-12	6"	1626		149	152	32.0
SP 300-13	6"	1739		149	152	34.3
SP 300-14	6"	1852	Rp 4" NPT 4"	149	152	36.5
SP 300-15	6"	1965	149	152	38.8	
SP 300-16	6"	2078	149	152	41.1	
SP 300-17	6"	2191	149	152	43.4	
SP 300-18	6"	2304	149	152	45.7	
SP 300-19	6"	2417	149	152	48.0	
SP 300-20	6"	2530	149	152	50.2	
SP 300-21	6"	2463	149	152	52.5	
SP 300-22	8"	2784	183	183	60.2	
SP 300-24	8"	3311	192	192	125.1	
SP 300-26	8"	3537	192	192	132.4	
SP 300-28	8"	3763	192	192	139.9	
SP 300-30	8"	3989	192	192	148.0	

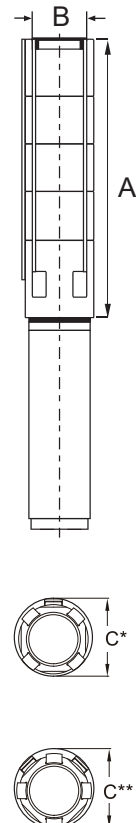

C* : Maximum diameter of pump with one motor cable

C** : Maximum diameter of pump with two motor cable

SP 300-24 to SP 300-30 are mounted in sleeve for R 4 connection

▶ With Sleeve

Performance Curves

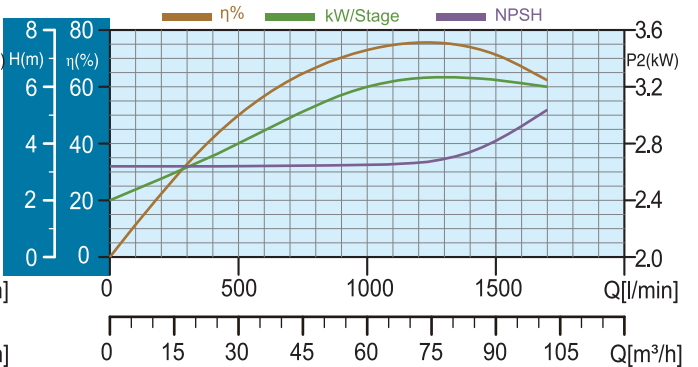
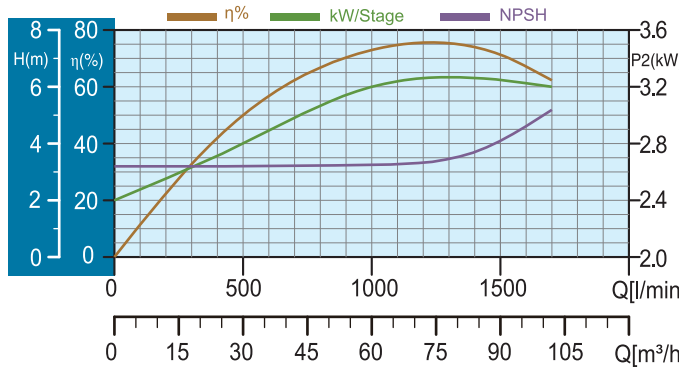
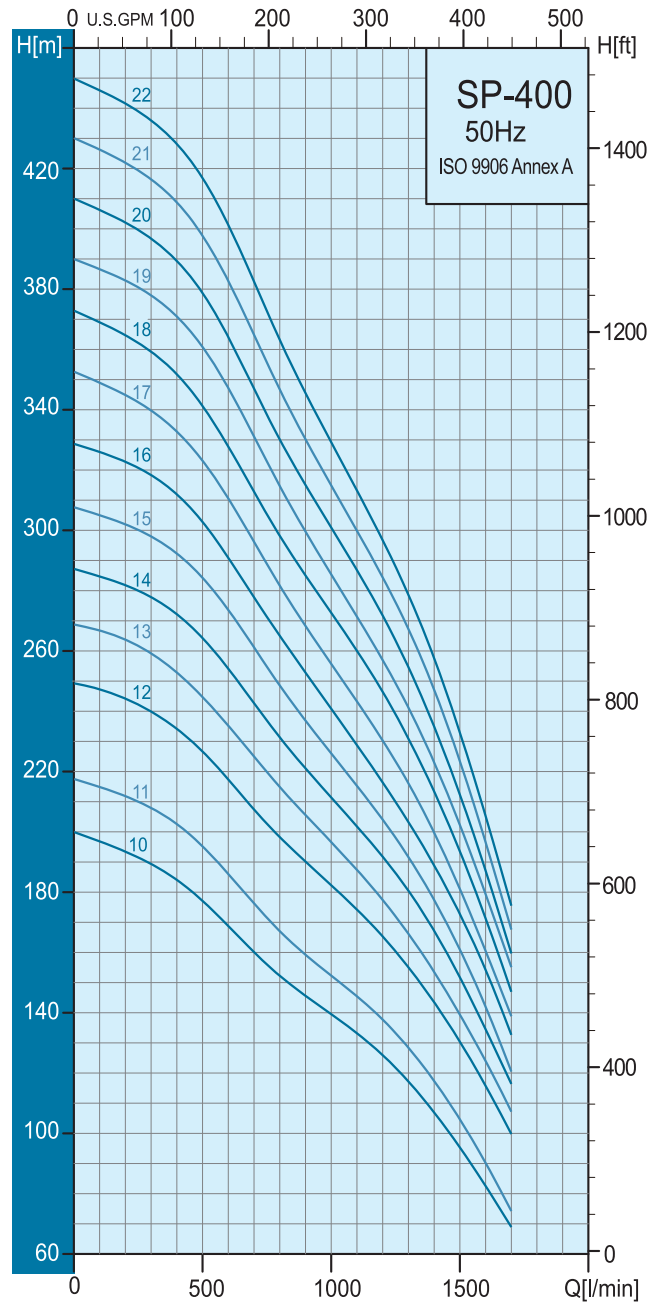
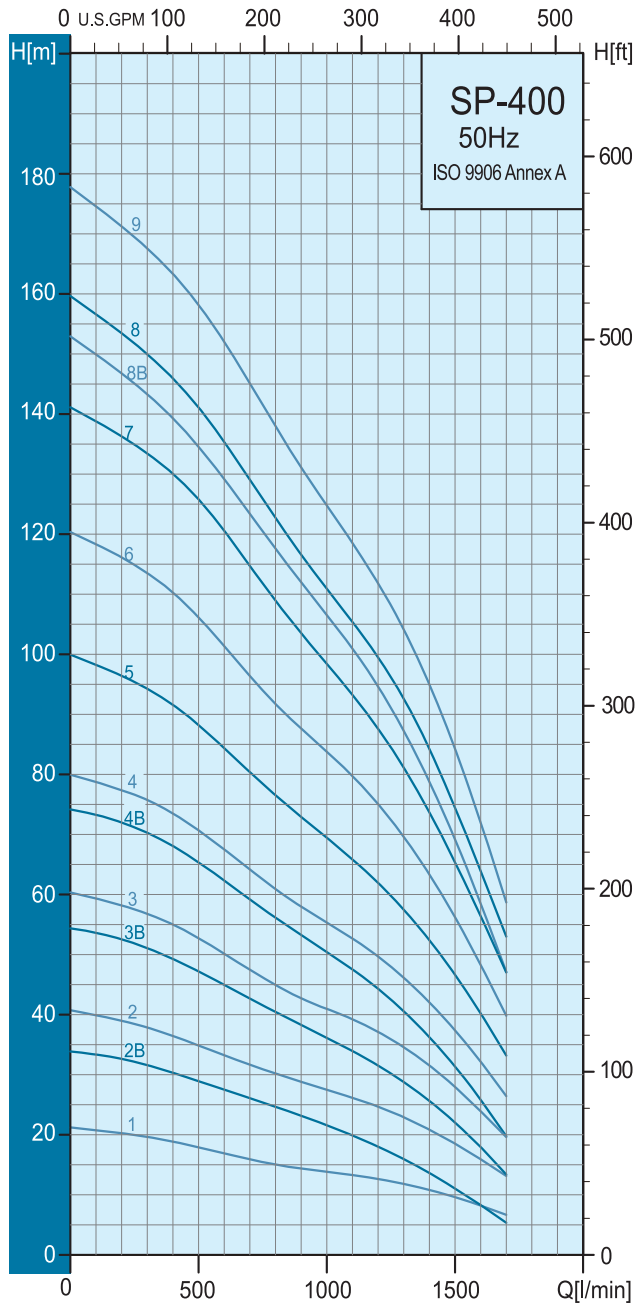

Specifications

Pump Type	Motor		Q=DELIVERY 2850rpm												
	P ₂		l/min	200	300	400	500	600	700	800	900	1100	1300	1500	1700
	kW	HP	m ³ /h	12.0	18.0	24.0	30.0	36.0	42.0	48.0	54.0	66.0	78.0	90.0	102.0
SP 400-1	5.5	7.5	H (m)	20.0	19.5	19.0	18.0	17.0	16.0	15.0	14.0	13.0	12.0	9.0	7.0
SP 400-2B	5.5	7.5		33.0	32.0	30.0	28.0	27.0	26.0	25.0	23.0	20.0	16.0	11.0	6.0
SP 400-2	7.5	10.0		38.0	37.0	36.0	35.0	33.0	32.0	30.0	28.0	26.0	23.0	18.0	13.0
SP 400-3B	9.3	12.5		53.0	51.0	49.0	47.0	45.0	43.0	40.0	38.0	34.0	28.0	22.0	13.0
SP 400-3	11.0	15.0		58.0	57.0	55.0	53.0	50.0	47.0	45.0	43.0	39.0	35.0	28.0	20.0
SP 400-4B	13.0	17.5		72.0	70.0	68.0	65.0	62.0	59.0	56.0	53.0	47.0	40.0	31.0	20.0
SP 400-4	15.0	20.0		77.0	76.0	74.0	71.0	67.0	64.0	61.0	58.0	53.0	46.0	37.0	27.0
SP 400-5	18.5	25.0		96.0	94.0	92.0	88.0	84.0	80.0	76.0	73.0	66.0	57.0	46.0	33.0
SP 400-6	22.0	30.0		116.0	113.0	110.0	106.0	101.0	96.0	92.0	88.0	80.0	70.0	56.0	40.0
SP 400-7	26.0	35.0		136.0	133.0	130.0	126.0	120.0	115.0	109.0	104.0	93.0	81.0	65.0	47.0
SP 400-8B	26.0	35.0		147.0	143.0	139.0	134.0	129.0	123.0	117.0	112.0	101.0	87.0	69.0	47.0
SP 400-8	30.0	40.0		153.0	150.0	146.0	141.0	135.0	129.0	123.0	117.0	105.0	93.0	75.0	53.0
SP 400-9	30.0	40.0		171.0	167.0	163.0	158.0	152.0	145.0	138.0	131.0	118.0	104.0	84.0	58.0
SP 400-10	37.0	50.0		193.0	188.0	183.0	177.0	168.0	160.0	152.0	145.0	132.0	117.0	94.0	68.0
SP 400-11	37.0	50.0		211.0	207.0	202.0	195.0	186.0	176.0	167.0	159.0	145.0	128.0	104.0	74.0
SP 400-12	45.0	60.0		244.0	240.0	234.0	227.0	217.0	207.0	198.0	190.0	173.0	154.0	130.0	99.0
SP 400-13	55.0	75.0		263.0	259.0	252.0	244.0	235.0	224.0	214.0	205.0	187.0	166.0	139.0	107.0
SP 400-14	55.0	75.0		281.5	277.5	272.0	264.0	253.5	242.0	231.0	220.5	201.0	180.0	151.0	115.5
SP 400-15	55.0	75.0		302.0	298.0	292.0	284.0	273.0	260.0	248.0	237.0	215.0	191.0	160.0	120.0
SP 400-16	63.0	85.0		322.0	318.0	312.0	302.0	290.0	278.0	265.0	252.0	228.0	202.0	172.0	132.0
SP 400-17	63.0	85.0		344.5	339.5	332.5	323.0	310.0	296.0	281.0	268.0	243.0	215.5	180.5	138.0
SP 400-18	63.0	85.0		365.0	359.0	352.0	341.0	328.0	312.0	298.0	285.0	260.0	230.0	193.0	147.0
SP 400-19	75.0	100.0	383.0	378.0	371.0	360.5	347.0	331.0	314.0	299.0	271.0	241.0	202.0	154.5	
SP 400-20	75.0	100.0	402.0	397.0	389.0	379.0	364.0	347.0	330.0	315.0	287.0	254.0	212.0	159.0	
SP 400-21	75.0	100.0	422.0	416.0	409.0	397.5	382.5	364.5	346.5	330.0	299.5	267.0	223.0	167.0	
SP 400-22	93.0	125.0	441.5	436.0	428.0	417.0	401.0	382.0	363.0	345.0	313.0	278.0	232.5	175.0	

*Higher pressure , longer stages pumps up to 22 stages are available on request.

Dimensions and Weights

Pump Type	Motor Dia.	Dimensions (mm)							Net Weight (kg)
		5" Connection			5" Flange				
		A	B	C*	C**	A	C*	C**	
SP 400-1	6"	618	Rp 5" NPT 5"	178	186	618	200	200	25.1
SP 400-2B	6"	746		178	186	746	200	200	28.7
SP 400-2	6"	746		178	186	746	200	200	28.7
SP 400-3B	6"	874		178	186	874	200	200	32.3
SP 400-3	6"	874		178	186	874	200	200	32.3
SP 400-4B	6"	1003		178	186	1003	200	200	35.9
SP 400-4	6"	1003		178	186	1003	200	200	35.9
SP 400-5	6"	1131		178	186	1131	200	200	39.5
SP 400-6	6"	1259		178	186	1259	200	200	43.0
SP 400-7	6"	1387		178	186	1387	200	200	46.6
SP 400-8B	6"	1515		178	186	1515	200	200	50.2
SP 400-8	6"	1515		178	186	1515	200	200	50.2
SP 400-9	6"	1644		178	186	1644	200	200	53.8
SP 400-10	6"	1772		178	186	1772	200	200	57.4
SP 400-11	6"	1900		178	186	1900	200	200	61.0
SP 400-12	8"	2039		200	204	2039	209	209	67.0
SP 400-13	8"	2168		200	204	2168	209	209	70.6
SP 400-14	8"	2296		200	204	2296	209	209	74.2
SP 400-15	8"	2424		200	204	-	-	-	77.8
SP 400-16	8"	2552		200	204	-	-	-	81.4
SP 400-17	8"	2680		200	204	-	-	-	85.2
SP 400-18	8"	2809		200	204	-	-	-	88.6
SP 400-19	8"	2937	200	204	-	-	-	92.2	
SP 400-20	8"	3065	200	204	-	-	-	95.8	
SP 400-21	8"	3193	200	204	-	-	-	99.4	
SP 400-22	8"	3321	200	204	-	-	-	103.0	

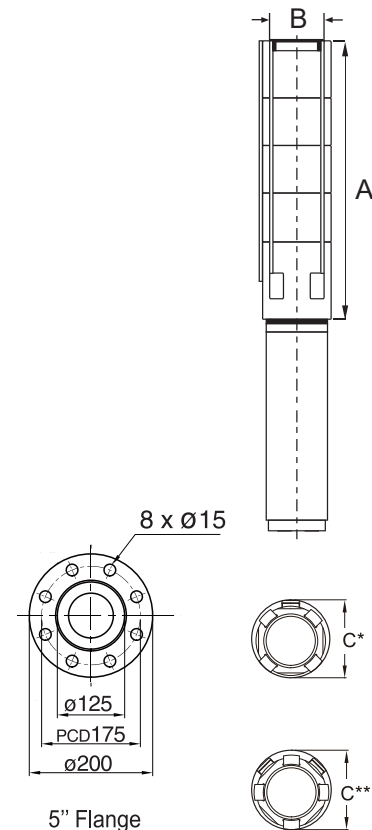

C* : Maximum diameter of pump with one motor cable
 C** : Maximum diameter of pump with two motor cable

Performance Curves

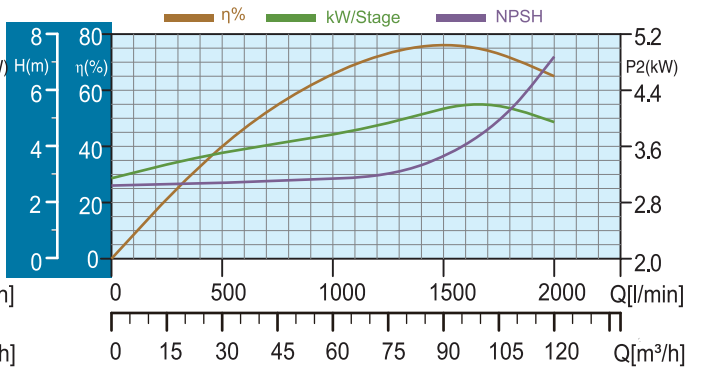
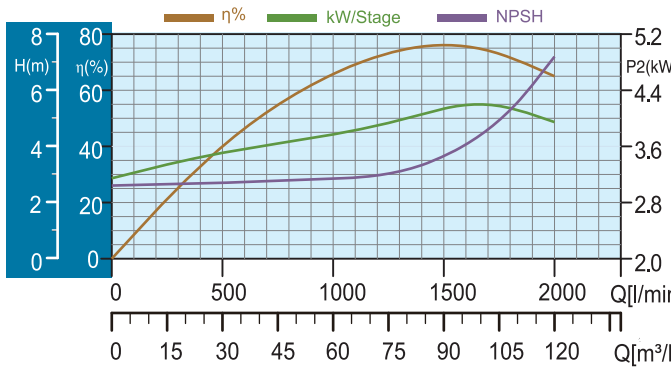
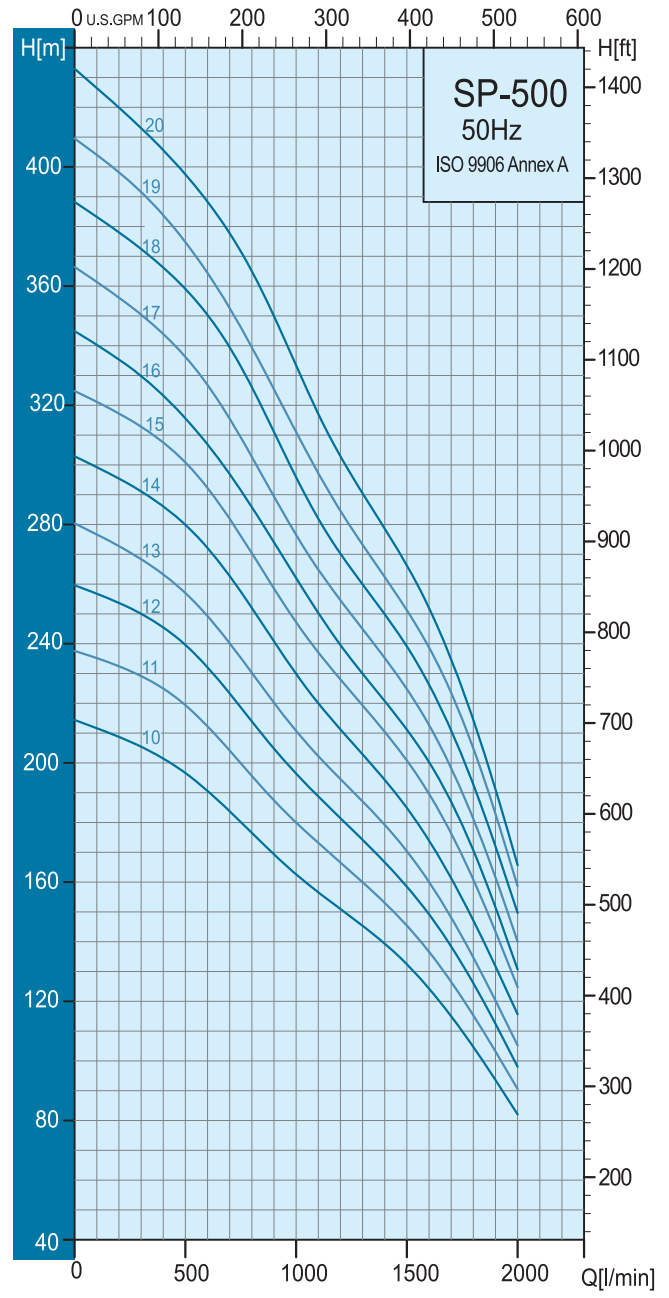
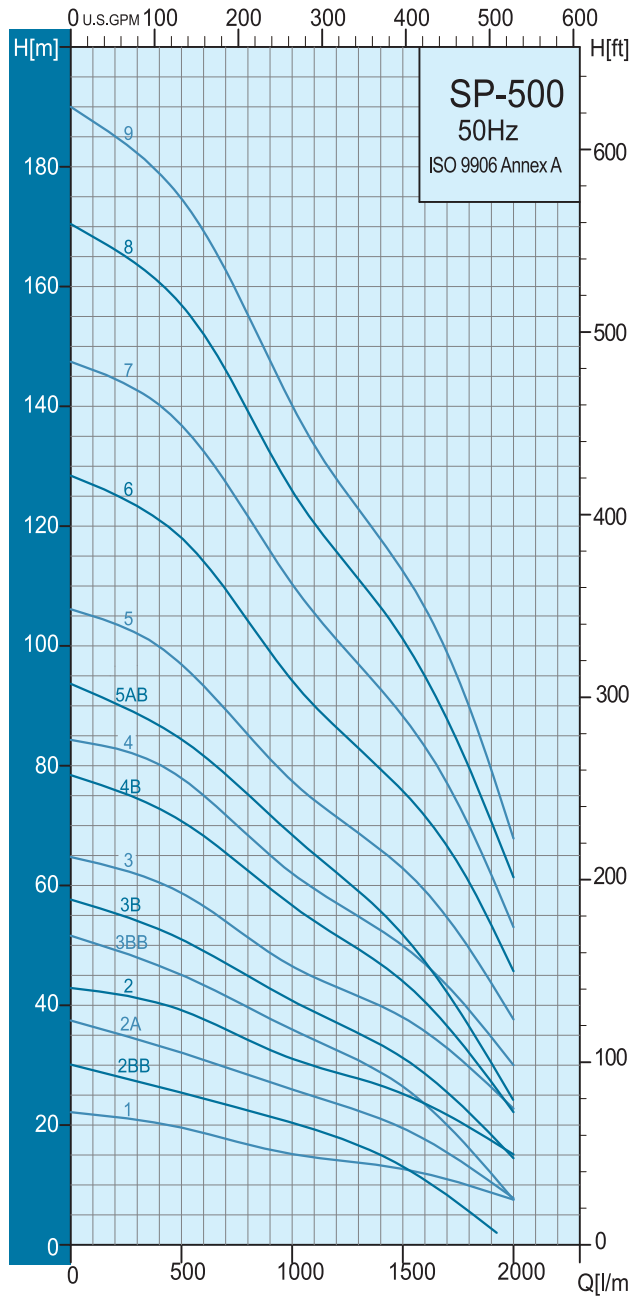

Specifications

Pump Type	Motor		Q=DELIVERY 2850rpm												
	P ₂		l/min	300	400	500	600	700	800	1000	1200	1400	1600	1800	2000
	kW	HP	m ³ /h	18.0	24.0	30.0	36.0	42.0	48.0	60.0	72.0	84.0	96.0	108.0	120.0
SP 500-1	5.5	7.5	H (m)	21.0	20.0	19.0	18.0	17.5	17.0	15.0	14.0	13.0	12.0	10.0	8.0
SP 500-2BB	5.5	7.5		27.0	26.0	25.0	24.0	23.0	22.0	20.0	18.0	15.0	11.0	5.0	-
SP 500-2A	7.5	10.0		34.0	33.0	32.0	31.0	30.0	28.0	26.0	24.0	21.0	17.0	13.0	8.0
SP 500-2	9.3	12.5		41.0	40.0	39.0	37.0	36.0	34.0	31.0	29.0	26.0	23.0	20.0	15.0
SP 500-3BB	9.3	12.5		48.0	46.0	45.0	43.0	41.0	40.0	36.0	33.0	28.0	23.0	16.0	8.0
SP 500-3B	11.0	15.0		54.0	53.0	51.0	49.0	47.0	45.0	41.0	37.0	33.0	28.0	22.0	15.0
SP 500-3	13.0	17.5		62.0	60.0	59.0	57.0	54.0	51.0	47.0	43.0	40.0	35.0	30.0	23.0
SP 500-4B	15.0	20.0		74.0	73.0	71.0	68.0	65.0	62.0	56.0	52.0	47.0	40.0	32.0	22.0
SP 500-4	18.5	25.0		82.0	80.0	78.0	75.0	72.0	68.0	62.0	57.0	53.0	47.0	39.0	30.0
SP 500-5AB	18.5	25.0		89.0	87.0	84.0	82.0	78.0	75.0	68.0	62.0	55.0	47.0	36.0	25.0
SP 500-5	22.0	30.0		102.0	100.0	97.0	94.0	90.0	85.0	77.0	72.0	66.0	59.0	50.0	38.0
SP 500-6	26.0	35.0		123.0	121.0	118.0	114.0	110.0	104.0	94.0	86.0	79.0	72.0	60.0	46.0
SP 500-7	30.0	40.0		143.0	140.0	137.0	132.0	127.0	121.0	110.0	101.0	93.0	83.0	70.0	53.0
SP 500-8	37.0	50.0		164.0	160.0	157.0	152.0	146.0	139.0	126.0	116.0	106.0	95.0	80.0	62.0
SP 500-9	37.0	50.0		182.0	179.0	175.0	169.0	163.0	155.0	140.0	128.0	118.0	106.0	90.0	68.0
SP 500-10	45.0	60.0		206.0	201.0	197.0	190.0	183.0	177.0	162.0	150.0	140.0	124.0	105.0	82.0
SP 500-11	55.0	75.0		230.0	225.0	220.0	212.0	204.0	196.0	180.0	167.0	152.0	137.0	116.0	90.0
SP 500-12	55.0	75.0		250.0	245.0	240.0	231.0	222.0	214.0	197.0	181.0	167.0	150.0	126.0	99.0
SP 500-13	55.0	75.0		268.0	263.0	258.0	250.0	240.0	230.0	210.0	195.0	180.0	160.0	135.0	106.0
SP 500-14	63.0	85.0		291.0	286.0	280.0	271.0	261.0	251.0	230.0	210.0	194.0	174.0	147.0	116.0
SP 500-15	75.0	100.0	312.0	308.0	300.0	292.0	281.0	270.0	248.0	228.0	210.0	190.0	160.0	126.0	
SP 500-16	75.0	100.0	330.0	323.0	315.5	307.0	297.0	286.0	261.5	239.5	220.5	200.0	170.5	130.5	
SP 500-17	75.0	100.0	350.0	344.0	336.0	327.0	316.0	302.0	277.0	255.0	235.0	212.0	180.0	140.0	
SP 500-18	93.0	125.0	372.0	366.0	360.0	350.0	340.0	326.0	296.0	270.0	250.0	227.0	192.0	150.0	
SP 500-19	93.0	125.0	391.5	384.0	374.5	364.0	352.5	339.0	311.0	284.5	262.0	238.5	205.0	158.5	
SP 500-20	93.0	125.0	412.0	406.0	397.0	388.0	378.0	365.0	333.0	302.0	279.0	251.0	214.0	166.0	

Dimensions and Weights

Pump Type	Motor Dia.	Dimensions (mm)								Net Weight (kg)
		A	B	C*	C**	A	B	C*	C**	
SP 500-1	6"	618	5" Connection (Rp ,NPT)	178	186	618	5" Flange	200	200	25.1
SP 500-2BB	6"	746		178	186	746		200	200	28.7
SP 500-2A	6"	746		178	186	746		200	200	28.7
SP 500-2	6"	746		178	186	746		200	200	28.7
SP 500-3BB	6"	874		178	186	874		200	200	32.3
SP 500-3B	6"	874		178	186	874		200	200	32.3
SP 500-3	6"	874		178	186	874		200	200	32.3
SP 500-4B	6"	1003		178	186	1003		200	200	35.9
SP 500-4	6"	1003		178	186	1003		200	200	35.9
SP 500-5AB	6"	1131		178	186	1131		200	200	39.5
SP 500-5	6"	1131		178	186	1131		200	200	39.5
SP 500-6	6"	1259		178	186	1259		200	200	43.0
SP 500-7	6"	1387		178	186	1387		200	200	46.6
SP 500-8	6"	1515		178	186	1515		200	200	50.2
SP 500-9	6"	1644		178	186	1644		200	200	53.8
SP 500-10	8"	1783		196	204	1783		205	205	60.1
SP 500-11	8"	1911		196	204	1911		205	205	63.7
SP 500-12	8"	2039		196	204	2039		205	205	67.3
SP 500-13	8"	2168		196	204	2168		205	205	71.0
SP 500-14	8"	2296		196	204	2296		205	205	74.6
SP 500-15	8"	2424	196	204	-	-	-	78.2		
SP 500-16	8"	2552	196	204	-	-	-	81.8		
SP 500-17	8"	2680	196	204	-	-	-	85.4		
SP 500-18	8"	2809	196	204	-	-	-	89.0		
SP 500-19	8"	2937	196	204	-	-	-	92.6		
SP 500-20	8"	3065	196	204	-	-	-	96.2		

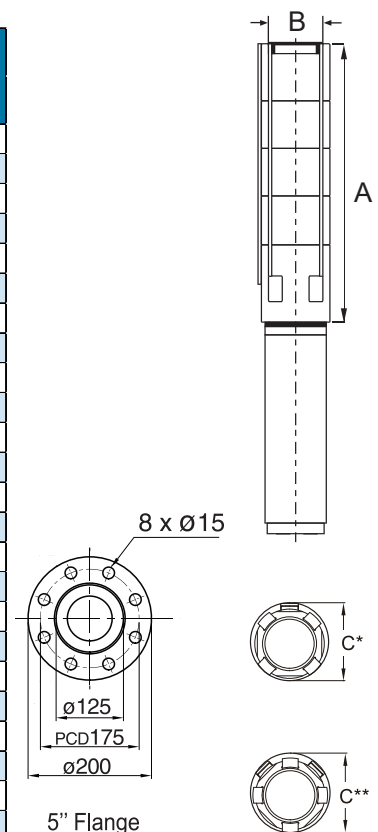

C* : Maximum diameter of pump with one motor cable
 C** : Maximum diameter of pump with two motor cable

Performance Curves

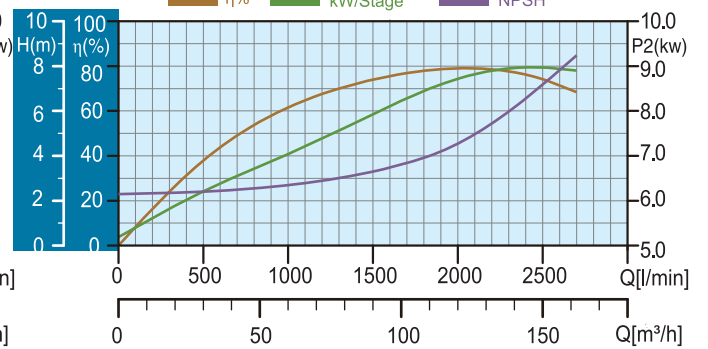
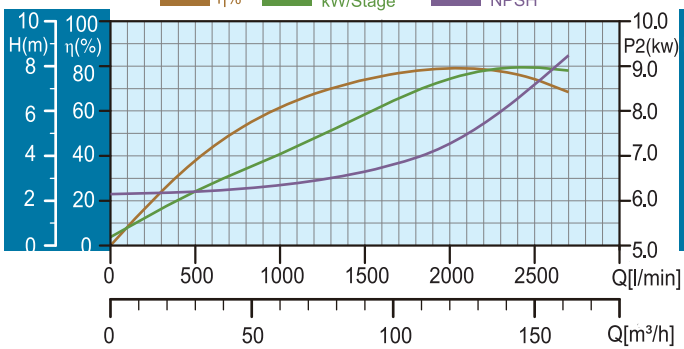
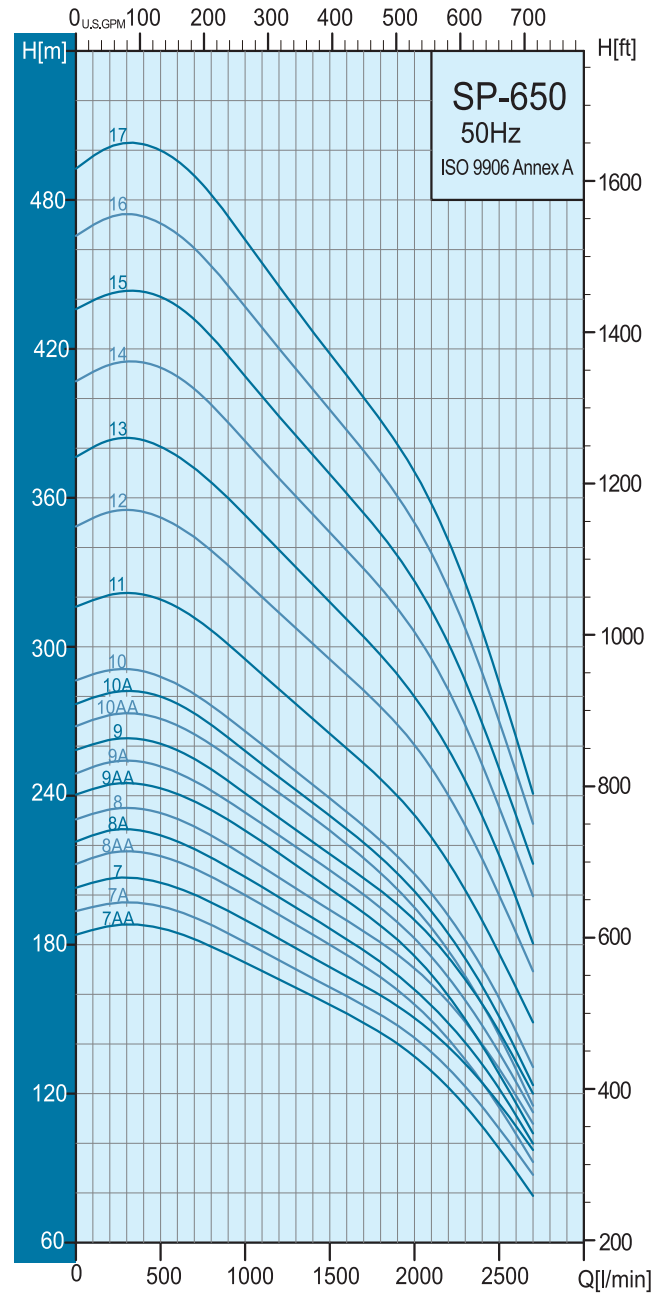
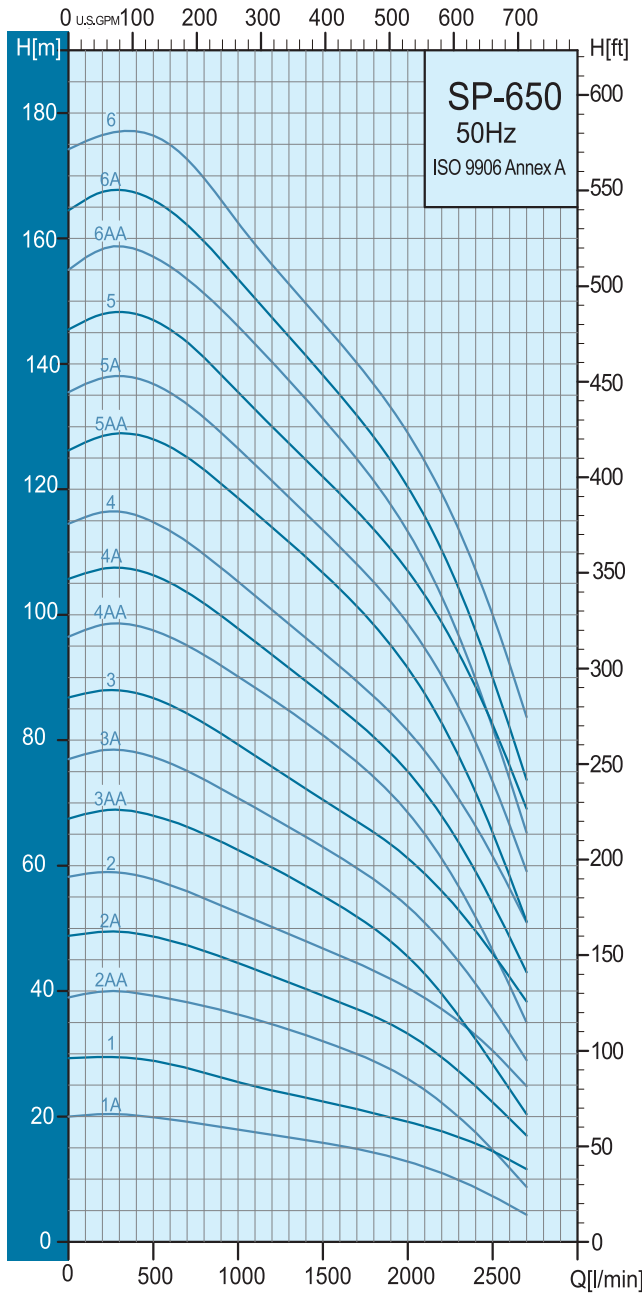

Specifications

Pump Type	Motor		Q=DELIVERY 2850rpm												
	P ₂		l/min	500	700	900	1100	1300	1500	1700	1900	2100	2300	2500	2700
	kW	HP	m ³ /h	30.0	42.0	54.0	66.0	78.0	90.0	102.0	114.0	126.0	138.0	150.0	162.0
SP 650-1-A	7.5	10.0	H (m)	19.9	19.0	18.3	17.5	16.5	15.8	14.9	13.5	12.0	9.8	7.3	4.0
SP 650-1	11.0	15.0		28.9	27.5	26.0	24.9	23.8	22.4	22.3	19.9	18.3	16.8	14.5	12.0
SP 650-2-AA	13.0	17.5		39.3	38.0	37.0	35.8	33.5	32.0	30.0	27.5	24.0	20.0	14.7	9.0
SP 650-2-A	18.5	25.0		48.7	47.5	45.6	43.5	41.4	39.3	37.5	34.7	31.7	27.5	22.3	17.0
SP 650-2	22.0	30.0		57.8	56.0	53.5	51.5	49.0	46.8	44.3	42.0	38.6	35.3	30.5	25.0
SP 650-3-AA	22.0	30.0		68.0	66.3	63.5	61.2	58.0	55.2	52.0	47.7	42.5	36.0	28.5	20.0
SP 650-3-A	26.0	35.0		77.3	75.0	72.5	69.2	66.4	63.0	59.7	56.0	51.0	44.6	37.3	29.0
SP 650-3	30.0	40.0		86.7	89.0	80.8	77.5	74.0	70.5	67.5	63.4	58.4	53.0	46.0	39.0
SP 650-4-AA	37.0	50.0		97.5	95.2	92.0	88.0	84.7	80.8	77.0	71.5	65.0	66.7	46.5	35.0
SP 650-4-A	37.0	50.0		106.3	103.5	99.7	96.0	91.5	87.3	83.0	77.8	71.7	63.5	54.0	43.0
SP 650-4	37.0	50.0		114.8	111.5	107.5	103.0	98.4	94.0	89.3	84.4	78.0	70.6	61.5	51.0
SP 650-5-AA	45.0	60.0		128.0	125.1	121.0	116.3	111.7	106.7	101.3	95.2	87.3	77.5	65.3	51.2
SP 650-5-A	45.0	60.0		136.8	133.4	128.7	124.0	118.7	113.5	108.2	101.9	94.6	85.4	73.4	59.2
SP 650-5	55.0	75.0		147.0	143.7	137.8	132.8	127.5	122.0	116.7	110.6	103.0	93.5	82.5	69.0
SP 650-6-AA	55.0	75.0		157.3	153.5	148.7	143.2	137.5	131.3	124.7	117.5	108.0	96.5	82.0	65.0
SP 650-6-A	55.0	75.0		166.2	162.3	156.4	150.6	144.4	138.2	131.7	124.5	115.5	104.0	90.0	74.0
SP 650-6	63.0	85.0		176.0	172.5	165.8	159.0	153.0	146.5	140.2	133.0	124.3	113.7	100.0	83.7

Dimensions and Weights

Pump Type	Motor Dia.	Dimensions (mm)				Net Weight (kg)
		A	B	C*	C**	
SP 650-1-A	6"	652	Rp 6" NPT 6"	211	218	29.2
SP 650-1	6"	652		211	218	29.26
SP 650-2-AA	6"	807		211	218	35.64
SP 650-2-A	6"	807		211	218	35.7
SP 650-2	6"	807		211	218	35.76
SP 650-3-AA	6"	963		211	218	42.14
SP 650-3-A	6"	963		211	218	42.2
SP 650-3	6"	963		211	218	42.26
SP 650-3	8"	963		213	218	47.06
SP 650-4-AA	6"	1118		211	218	48.64
SP 650-4-AA	8"	1118		213	218	51.94
SP 650-4-A	6"	1118		211	218	48.7
SP 650-4-A	8"	1118		213	218	52.0
SP 650-4	6"	1118		211	218	48.76
SP 650-4	8"	1118		213	218	52.06
SP 650-5-AA	6"	1274		211	218	55.14
SP 650-5-AA	8"	1274		213	218	56.94
SP 650-5-A	6"	1274		211	218	55.2
SP 650-5-A	8"	1274	213	218	57.0	
SP 650-5	8"	1274	213	218	57.06	
SP 650-6-AA	8"	1429	213	218	61.9	
SP 650-6-A	8"	1429	213	218	62.0	
SP 650-6	8"	1429	213	218	61.9	

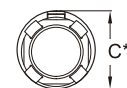
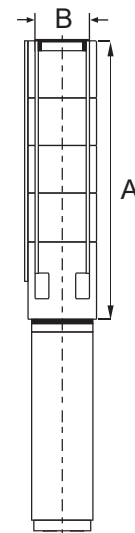

Performance Curves

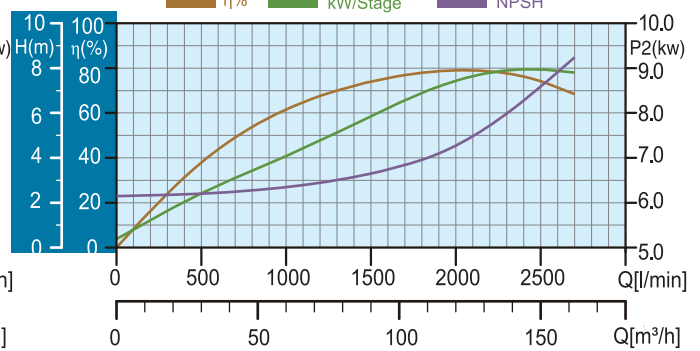
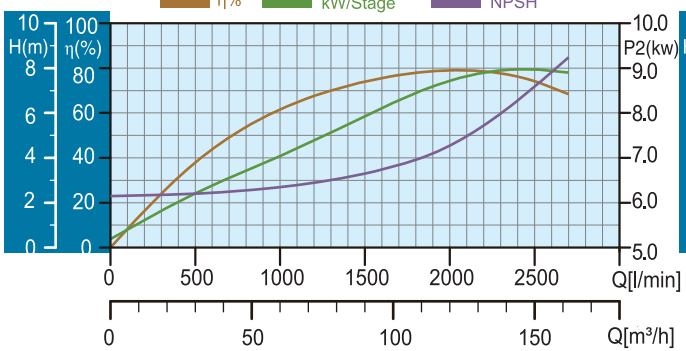
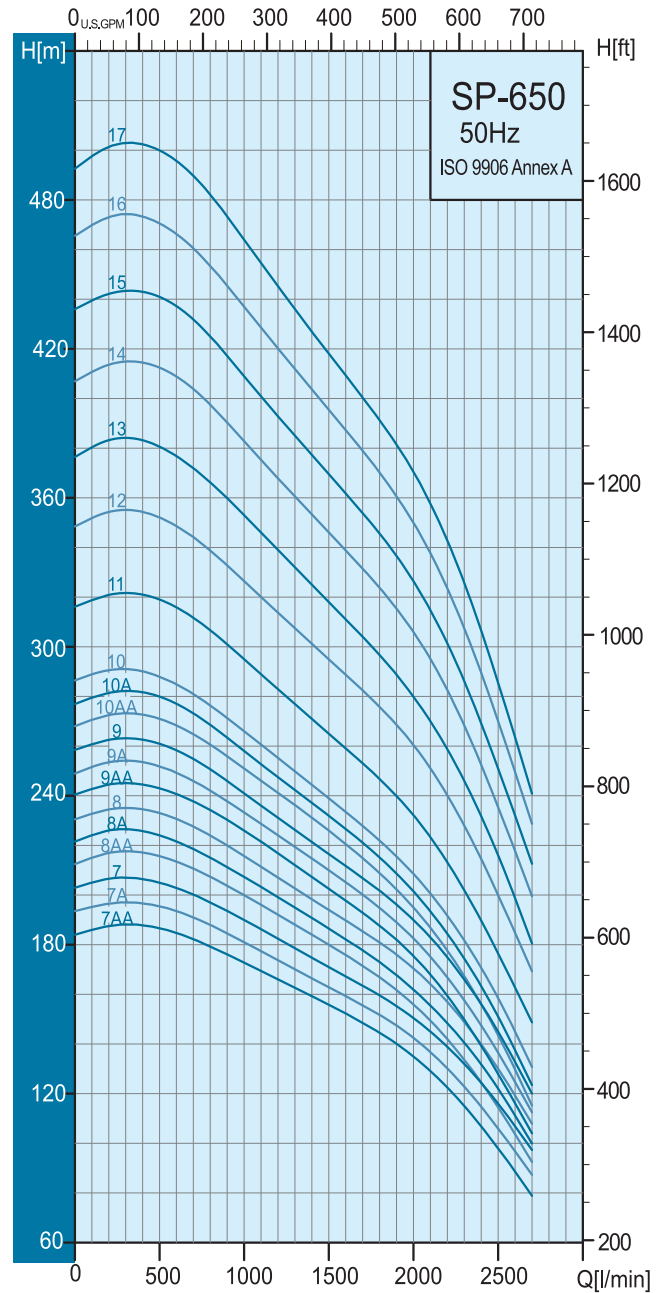
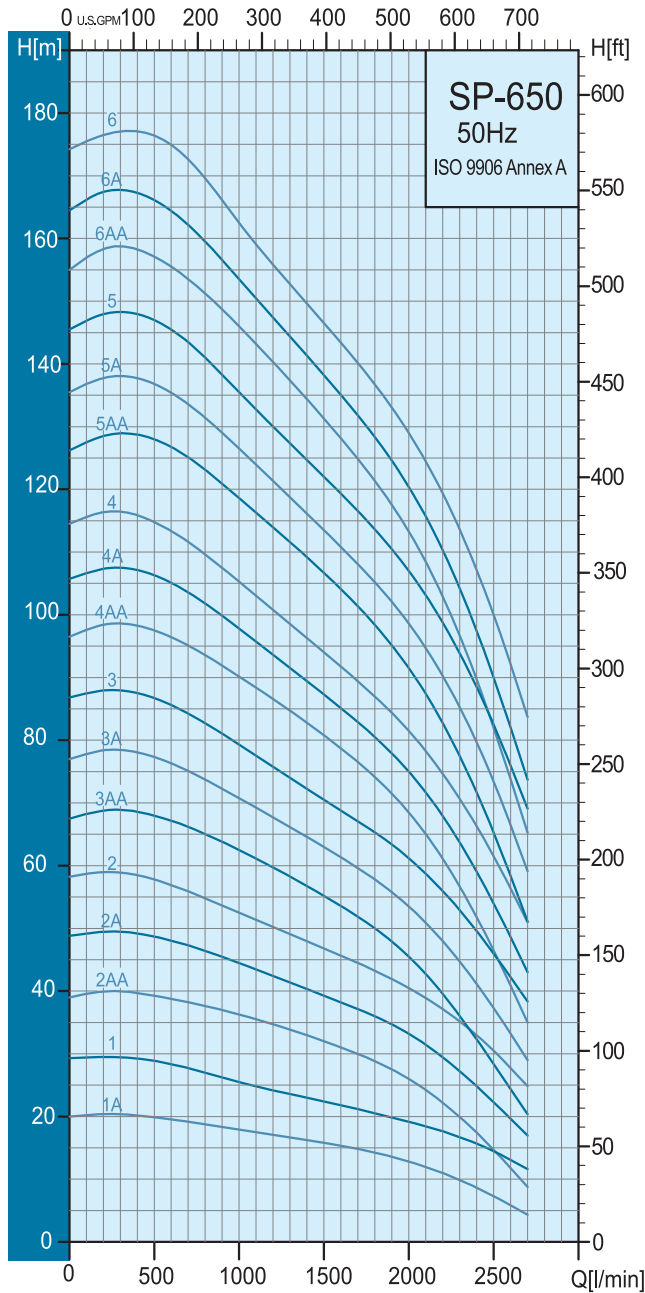

Specifications

Pump Type	Motor		Q=DELIVERY 2850rpm												
	P ₂		l/min	500	700	900	1100	1300	1500	1700	1900	2100	2300	2500	2700
	kW	HP	m ³ /h	30.0	42.0	54.0	66.0	78.0	90.0	102.0	114.0	126.0	138.0	150.0	162.0
SP 650-7-AA	63.0	85.0	H (m)	186.5	182.5	176.0	169.7	162.5	155.8	148.4	140.0	129.0	115.0	98.0	78.5
SP 650-7-A	63.0	85.0		195.5	191.2	185.0	177.5	170.0	162.8	155.4	147.5	137.0	122.5	106.0	82.5
SP 650-7	75.0	100.0		205.0	200.0	194.0	186.2	178.4	171.0	164.0	155.0	145.0	132.0	116.0	97.5
SP 650-8-AA	75.0	100.0		216.0	210.8	204.4	196.0	188.0	180.0	171.8	162.0	149.3	133.5	114.5	92.5
SP 650-8-A	75.0	100.0		224.0	218.0	212.0	203.7	195.0	186.5	177.5	167.5	155.5	140.5	122.0	100.0
SP 650-8	75.0	100.0		233.0	227.4	220.0	211.6	202.5	194.0	185.5	176.0	164.5	148.5	130.0	108.0
SP 650-9-AA	93.0	125.0		243.0	237.5	230.3	221.4	212.0	202.5	193.0	182.0	167.5	150.0	128.0	104.3
SP 650-9-A	93.0	125.0		251.8	245.0	237.0	228.3	219.4	210.0	200.0	189.0	175.0	157.5	136.5	113.0
SP 650-9	93.0	125.0		261.0	255.0	246.0	235.7	226.0	216.5	207.0	196.4	183.0	166.0	145.0	120.0
SP 650-10-AA	93.0	125.0		271.0	265.0	256.0	246.0	236.3	226.0	215.0	202.5	186.0	167.0	143.5	115.0
SP 650-10-A	93.0	125.0		280.0	273.0	263.7	253.0	242.7	232.0	221.0	208.5	193.0	174.5	151.0	123.4
SP 650-10	93.0	125.0		288.0	281.0	271.4	260.7	250.0	239.0	227.3	215.4	201.0	181.8	158.5	131.0
SP 650-11	110.0	150.0		319.0	312.0	301.3	288.7	277.0	265.0	253.8	240.0	223.0	202.0	176.5	148.8
SP 650-12	132.0	175.0		352.0	344.7	333.0	320.0	307.5	295.0	282.5	268.5	251.4	227.8	200.0	169.0
SP 650-13	132.0	175.0		380.5	372.0	360.0	346.0	332.0	318.0	304.3	288.5	270.0	246.0	216.0	180.0
SP 650-14	147.0	200.0		412.5	404.0	390.4	375.0	360.5	346.0	331.8	315.8	295.0	268.5	235.5	199.5
SP 650-15	147.0	200.0		441.0	431.4	417.0	401.0	385.0	369.5	354.0	336.3	315.0	286.0	251.0	213.0
SP 650-16	170.0	230.0		471.0	460.4	445.3	428.0	412.0	395.5	378.8	360.7	337.8	307.5	270.0	229.2
SP 650-15	147.0	200.0		500.0	489.7	473.2	454.8	436.0	418.0	405.5	381.5	357.5	325.0	285.5	241.3

Dimensions and Weights

Pump Type	Motor Dia.	Dimensions (mm)				Net Weight (kg)
		A	B	C*	C**	
SP 650-7-AA	8"	1585	Rp 6" NPT 6"	218	227	66.9
SP 650-7-A	8"	1585		218	227	67.0
SP 650-7	8"	1585		218	227	67.1
SP 650-8-AA	8"	1740		218	227	71.9
SP 650-8-A	8"	1740		218	227	72.0
SP 650-8	8"	1740		218	227	72.1
SP 650-9-AA	8"	1896		218	227	76.9
SP 650-9-A	8"	1896		218	227	77.0
SP 650-9	8"	1896		218	227	77.1
SP 650-10-AA	8"	2051		218	227	81.9
SP 650-10-A	8"	2051		218	227	82.0
SP 650-10	8"	2051		218	227	82.1
SP 650-11	8"	2207		218	227	87.1
SP 650-12	10"	2492		227	247	109.5
SP 650-13	10"	2648		227	247	116.0
SP 650-14	10"	2803		227	247	122.5
SP 650-15	10"	2959		227	247	129.0
SP 650-16	10"	3114		227	247	135.5
SP 650-17	10"	3270		227	247	142.0

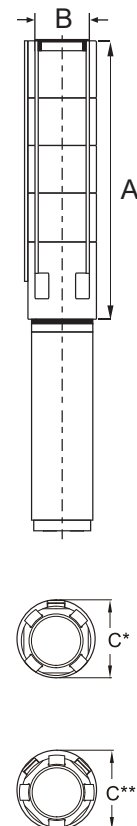

C* : Maximum diameter of pump with one motor cable
 C** : Maximum diameter of pump with two motor cable

Performance Curves

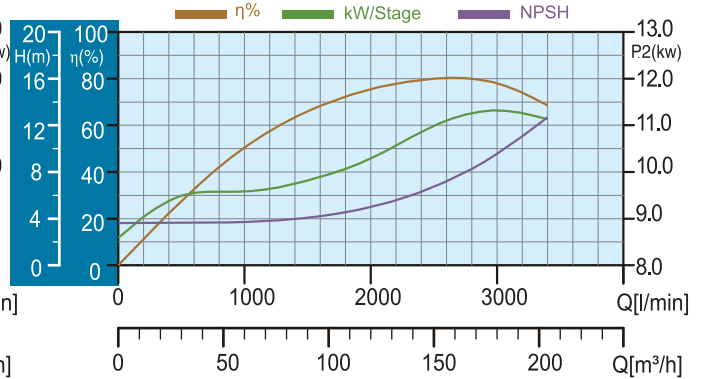
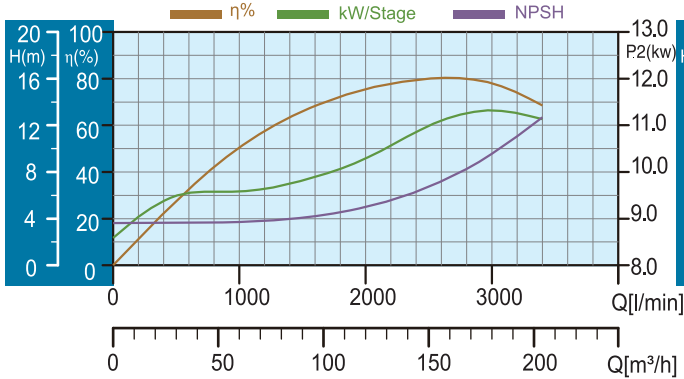
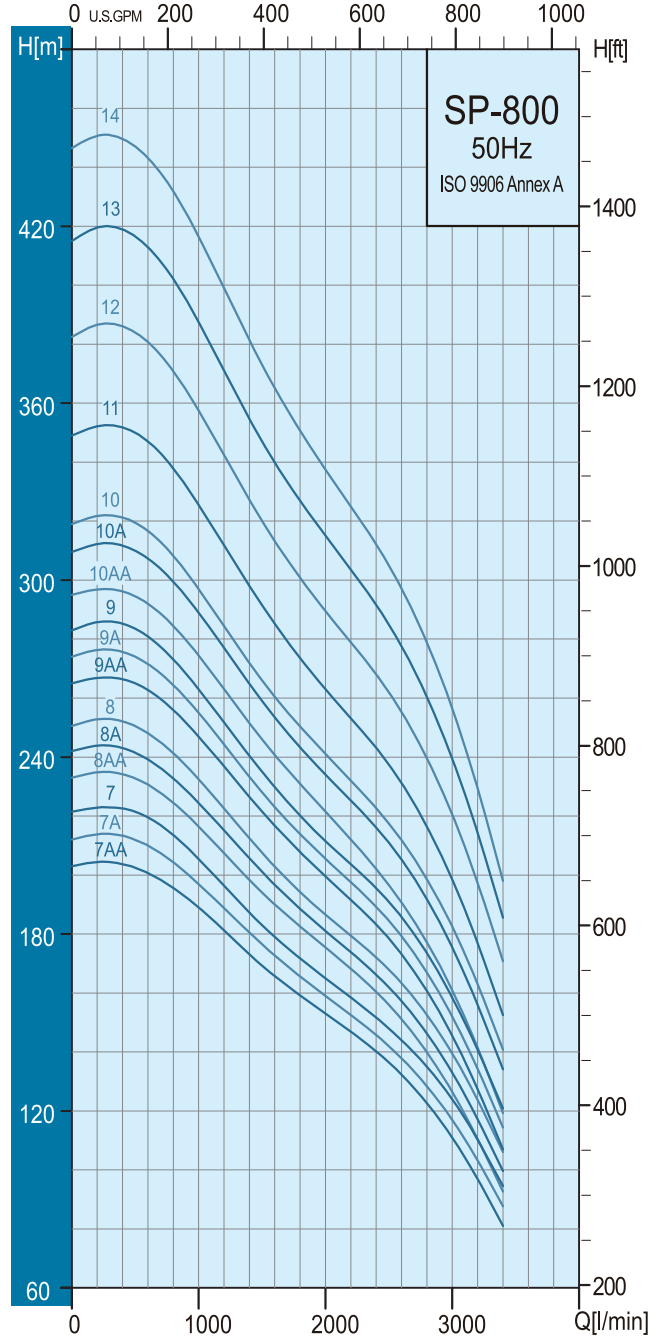
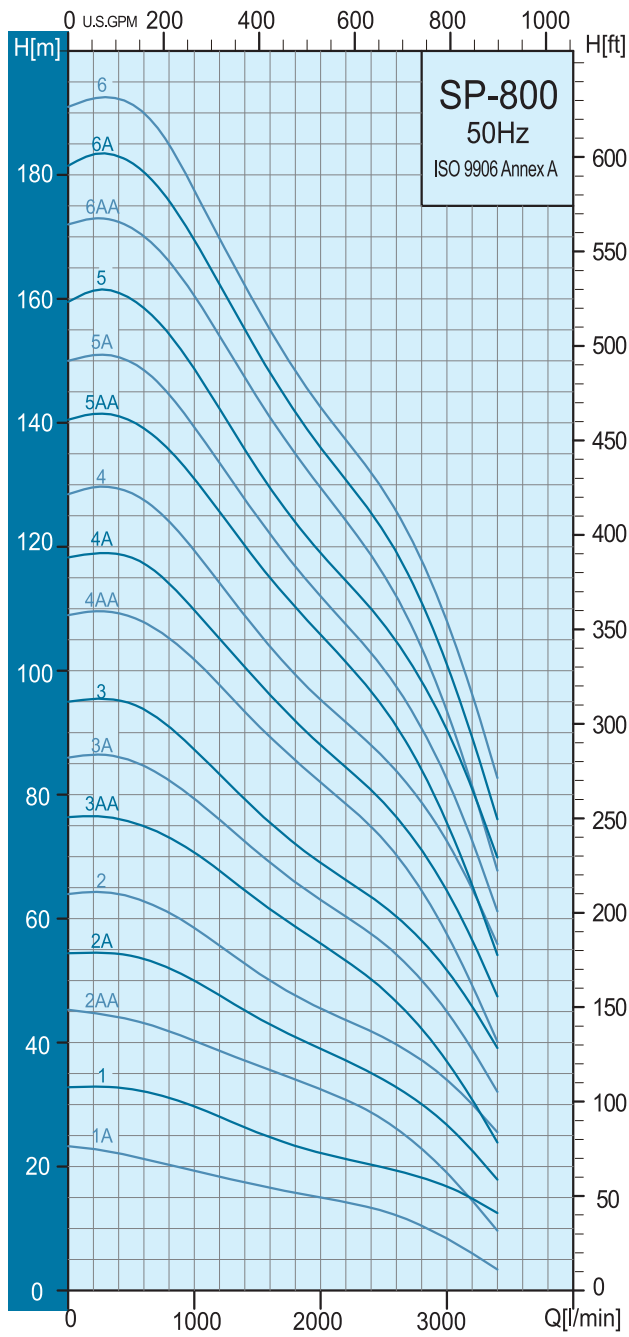

Specifications

Pump Type	Motor		Q=DELIVERY 2850rpm										
	P ₂		l/min	600	900	1200	1500	1800	2100	2400	2700	3000	3300
	kW	HP	m ³ /h	36.0	54.0	72.0	90.0	108.0	126.0	144.0	162.0	180.0	198.0
SP 800-1-A	9.3	12.5	H (m)	21.0	20.0	18.0	17.0	16.0	15.0	13.0	12.0	8.0	5.0
SP 800-1	13.0	17.5		32.0	31.0	28.0	25.0	24.0	22.0	20.0	19.0	17.0	14.0
SP 800-2-AA	18.5	25.0		43.0	41.0	39.0	36.0	34.0	32.0	29.0	25.0	19.0	12.0
SP 800-2-A	22.0	30.0		53.0	51.0	48.0	44.0	41.0	38.0	35.0	32.0	27.0	20.0
SP 800-2	26.0	35.0		63.0	60.0	56.0	51.0	48.0	45.0	42.0	38.0	34.0	28.0
SP 800-3-AA	30.0	40.0		75.0	72.0	68.0	63.0	59.0	55.0	50.0	45.0	37.0	28.0
SP 800-3-A	37.0	50.0		85.0	81.0	76.0	71.0	66.0	62.0	58.0	52.0	45.0	36.0
SP 800-3	37.0	50.0		94.0	89.0	83.0	78.0	72.0	68.0	64.0	59.0	52.0	43.0
SP 800-4-AA	45.0	60.0		108.0	104.0	98.0	91.0	85.0	80.0	75.0	68.0	57.0	45.0
SP 800-4-A	45.0	60.0		117.0	112.0	105.0	98.0	92.0	86.0	81.0	74.0	65.0	52.0
SP 800-4	55.0	75.0		128.0	122.0	114.0	106.0	99.0	94.0	88.0	81.0	73.0	61.0
SP 800-5-AA	55.0	75.0		139.0	134.0	126.0	118.0	110.0	104.0	97.0	88.0	75.0	60.0
SP 800-5-A	55.0	75.0		148.0	142.0	134.0	125.0	117.0	110.0	103.0	94.0	82.0	67.0
SP 800-5	63.0	85.0		158.0	152.0	142.0	132.0	124.0	117.0	110.0	102.0	90.0	76.0
SP 800-6-AA	63.0	85.0		170.0	163.0	154.0	144.0	135.0	127.0	119.0	108.0	93.0	75.0
SP 800-6-A	75.0	100.0		180.0	173.0	162.0	152.0	142.0	133.0	125.0	115.0	101.0	83.0
SP 800-6	75.0	100.0		190.0	182.0	170.0	158.0	148.0	140.0	132.0	122.0	108.0	90.0

Dimensions and Weights

Pump Type	Motor Dia.	Dimensions (mm)				Net Weight (kg)
		A	B	C*	C**	
SP 800-1-A	6"	652	Rp 6" NPT 6"	211	218	30.40
SP 800-1	6"	652		211	218	30.40
SP 800-2-AA	6"	807		211	218	36.74
SP 800-2-A	6"	807		211	218	36.82
SP 800-2	6"	807		211	218	36.82
SP 800-3-AA	6"	963		211	218	43.16
SP 800-3-A	6"	963		211	218	43.24
SP 800-3	6"	963		211	218	43.24
SP 800-4-AA	8"	1118		218	227	50.90
SP 800-4-A	8"	1118		218	227	50.98
SP 800-4	8"	1118		218	227	50.98
SP 800-5-AA	8"	1274		218	227	57.32
SP 800-5-A	8"	1274		218	227	57.40
SP 800-5	8"	1274		218	227	57.40
SP 800-6-AA	8"	1429		218	227	63.74
SP 800-6-A	8"	1429		218	227	63.82
SP 800-6	8"	1429		218	227	63.82

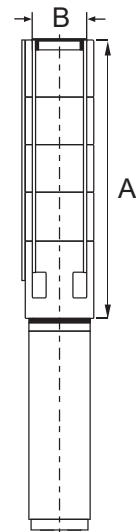

C* : Maximum diameter of pump with one motor cable
 C** : Maximum diameter of pump with two motor cable

Performance Curves

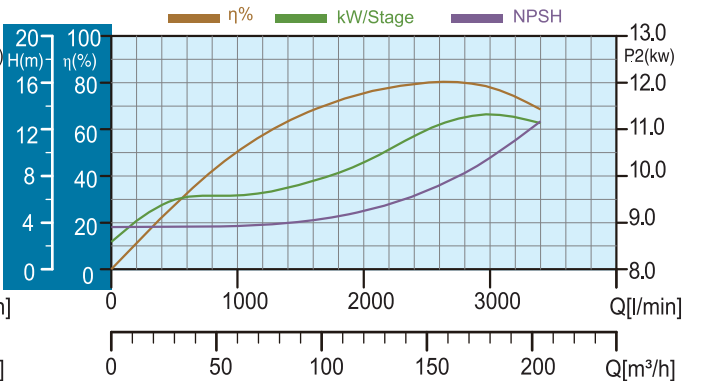
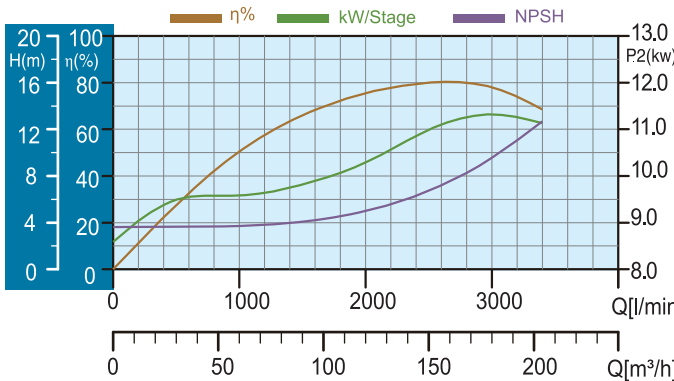
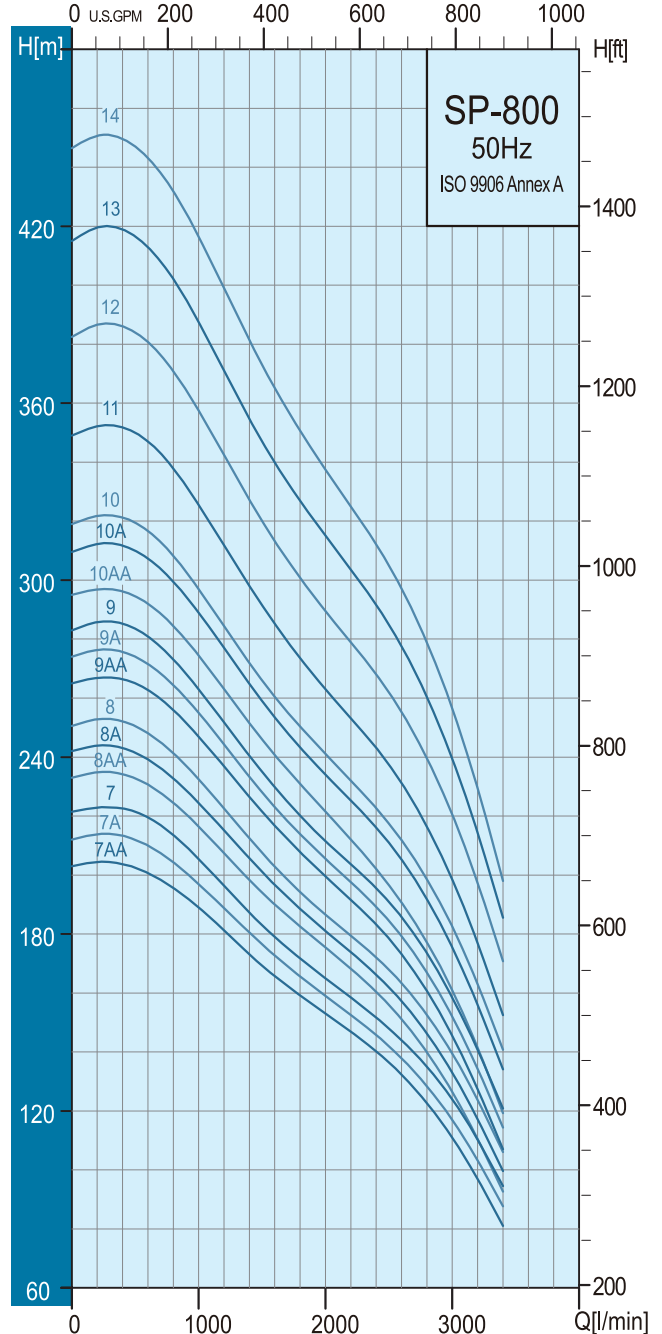
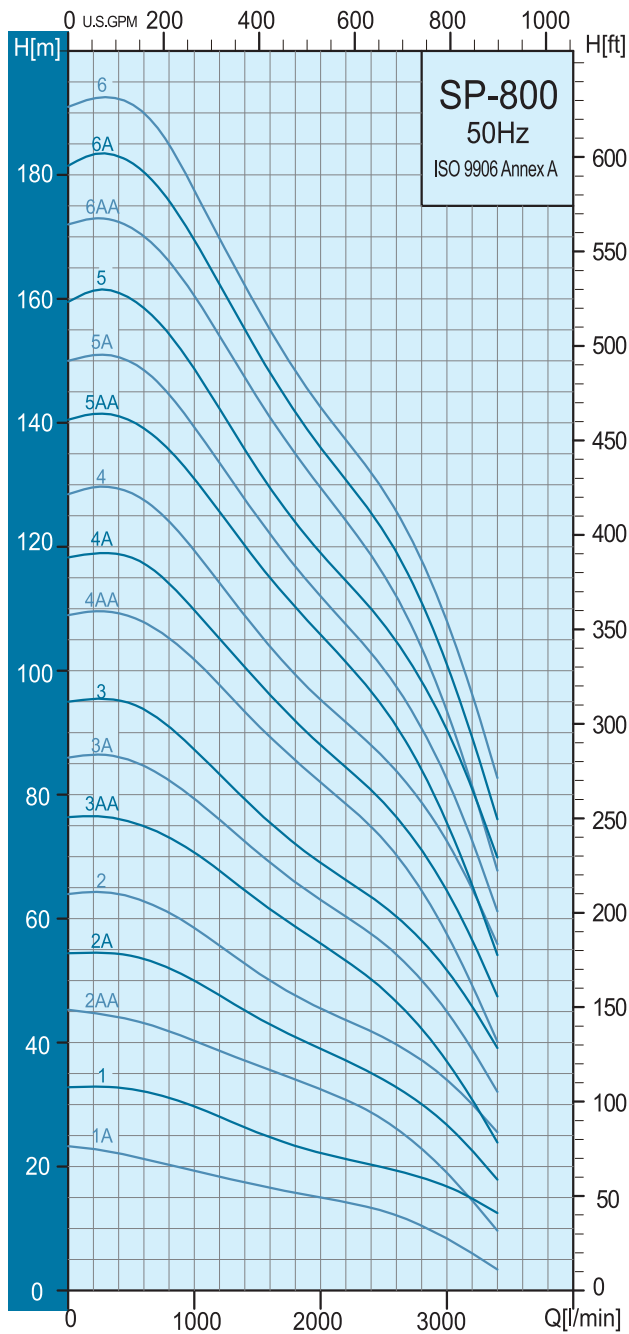

Specifications

Pump Type	Motor		Q=DELIVERY 2850rpm										
	P ₂		l/min	600	900	1200	1500	1800	2100	2400	2700	3000	3300
	kW	HP	m ³ /h	36.0	54.0	72.0	90.0	108.0	126.0	144.0	162.0	180.0	198.0
SP 800-7-AA	75.0	100.0	H (m)	200.0	193.0	181.0	169.0	159.0	150.0	140.0	128.0	111.0	89.0
SP 800-7-A	93.0	125.0		210.0	201.0	188.0	177.0	166.0	156.0	146.0	134.0	117.0	96.0
SP 800-7	93.0	125.0		220.0	210.0	196.0	183.0	172.0	162.0	152.0	140.0	124.0	102.0
SP 800-8-AA	93.0	125.0		230.0	220.0	208.0	194.0	183.0	172.0	160.0	146.0	126.0	102.0
SP 800-8-A	93.0	125.0		239.0	229.0	215.0	201.0	189.0	177.0	167.0	152.0	133.0	108.0
SP 800-8	93.0	125.0		248.0	237.0	222.0	208.0	194.0	183.0	172.0	158.0	140.0	115.0
SP 800-9-AA	110.0	150.0		263.0	252.0	237.0	222.0	208.0	196.0	183.0	167.0	146.0	117.0
SP 800-9-A	110.0	150.0		272.0	260.0	244.0	228.0	214.0	202.0	189.0	174.0	152.0	124.0
SP 800-9	110.0	150.0		281.0	268.0	252.0	235.0	220.0	207.0	196.0	180.0	159.0	131.0
SP 800-10-AA	110.0	150.0		292.0	280.0	263.0	246.0	231.0	217.0	202.0	184.0	161.0	131.0
SP 800-10-A	132.0	175.0		307.0	295.0	277.0	259.0	244.0	230.0	216.0	199.0	176.0	145.0
SP 800-10	132.0	175.0		317.0	303.0	284.0	266.0	250.0	236.0	223.0	205.0	182.0	152.0
SP 800-11	132.0	175.0		347.0	332.0	312.0	292.0	274.0	258.0	243.0	224.0	199.0	165.0
SP 800-12	147.0	200.0		380.0	365.0	342.0	320.0	301.0	285.0	268.0	248.0	221.0	184.0
SP 800-13	170.0	230.0		413.0	395.0	371.0	347.0	327.0	309.0	292.0	269.0	240.0	200.0
SP 800-14	170.0	230.0		443.0	425.0	399.0	373.0	350.0	332.0	312.0	288.0	257.0	213.0

Dimensions and Weights

Pump Type	Motor Dia.	Dimensions (mm)				Net Weight (kg)
		A	B	C*	C**	
SP 800-7-AA	8"	1585	Rp 6" NPT 6"	218	227	70.16
SP 800-7-A	8"	1585		218	227	70.24
SP 800-7	8"	1585		218	227	70.24
SP 800-8-AA	8"	1740		218	227	76.58
SP 800-8-A	8"	1740		218	227	76.66
SP 800-8	8"	1740		218	227	76.66
SP 800-9-AA	8"	1896		218	227	83.00
SP 800-9-A	8"	1896		218	227	83.08
SP 800-9	8"	1896		218	227	83.08
SP 800-10-AA	8"	2051		218	227	89.42
SP 800-10-A	10"	2181		227	247	102.62
SP 800-10	10"	2181		227	247	102.62
SP 800-11	10"	2337		227	247	109.04
SP 800-12	10"	2492		227	247	115.46
SP 800-13	10"	2648		227	247	121.88
SP 800-14	10"	2803		227	247	128.30

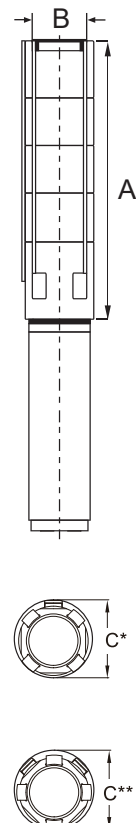

C* : Maximum diameter of pump with one motor cable
 C** : Maximum diameter of pump with two motor cable

Performance Curves

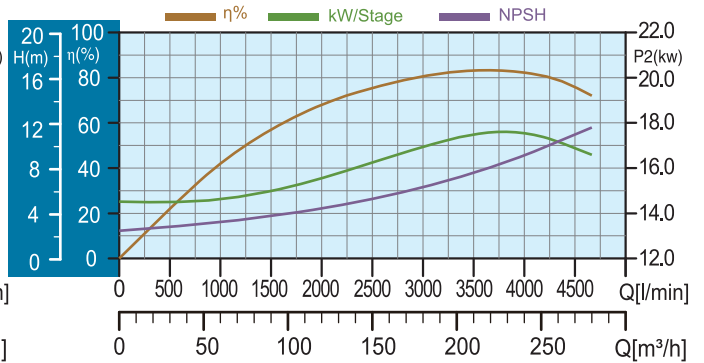
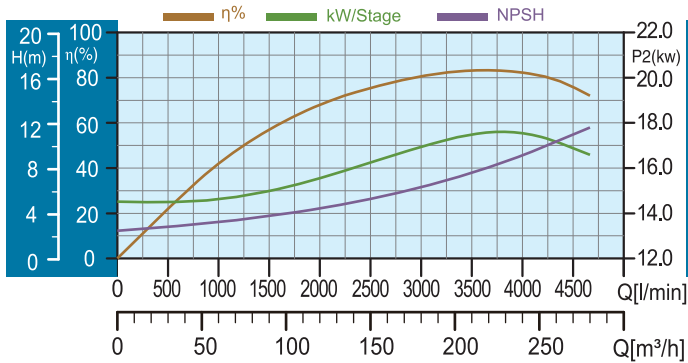
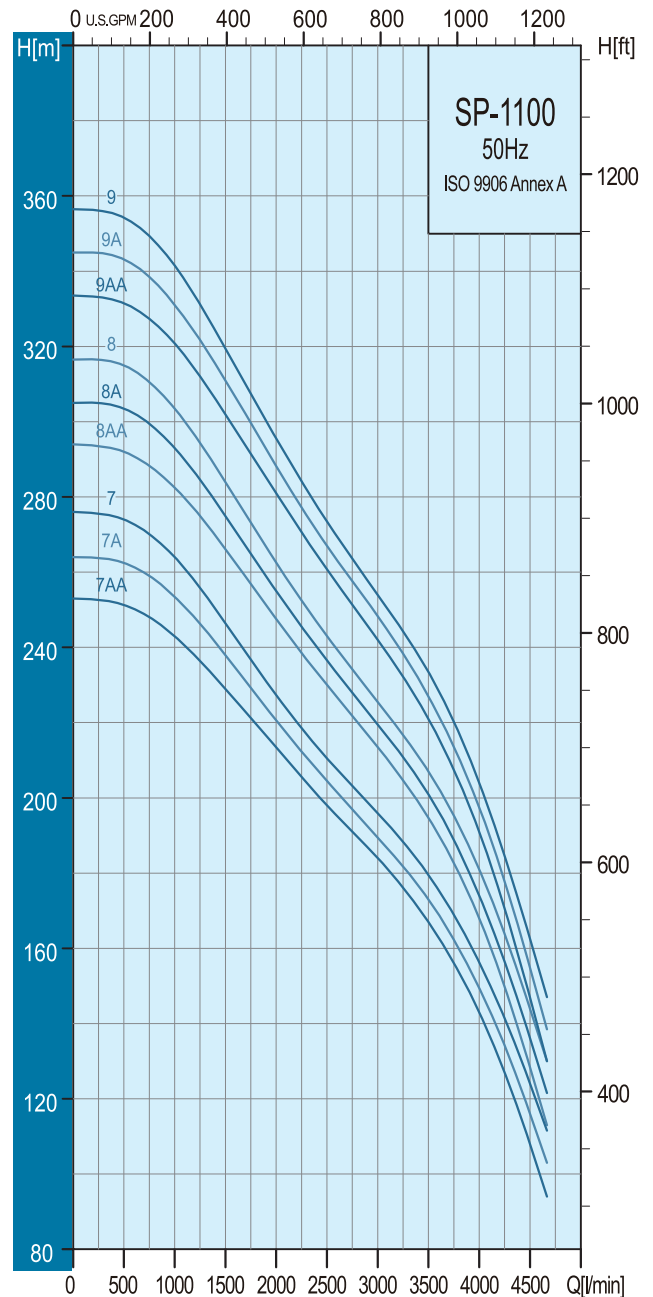
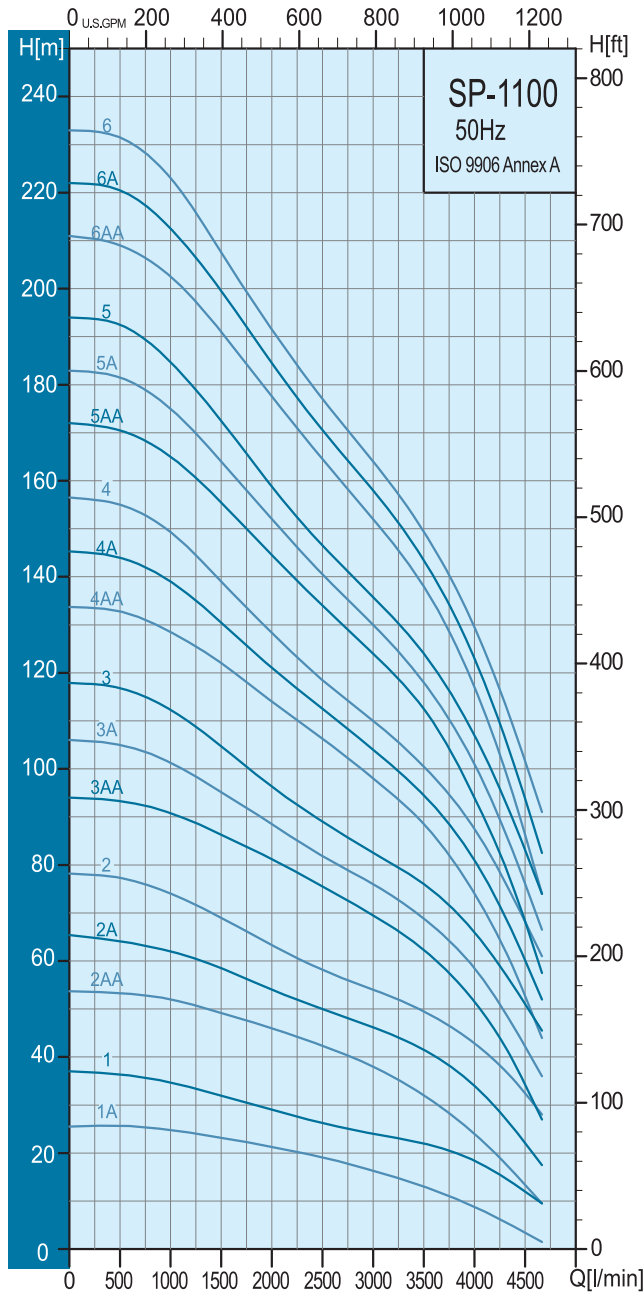

Specifications

Pump Type	Motor		Q=DELIVERY 2850rpm											
	P ₂		l/min	500	750	1000	1250	1500	2000	2500	3000	3500	4000	4500
	kW	HP	m ³ /h	30.0	45.0	60.0	75.0	90.0	120.0	150.0	180.0	210.0	240.0	270.0
SP 1100-1-A	15.0	20.0	H (m)	26.0	25.5	25.0	24.0	23.0	21.0	19.0	16.0	13.0	9.0	4.0
SP 1100-1	18.5	25.0		36.5	36.0	35.0	33.0	32.0	29.0	26.0	24.0	22.0	18.0	12.0
SP 1100-2-AA	30.0	40.0		53.0	52.5	52.0	50.0	49.0	46.0	42.0	38.0	32.0	24.0	14.0
SP 1100-2-A	37.0	50.0		64.0	63.0	62.0	60.0	58.0	54.0	50.0	46.0	41.0	34.0	22.0
SP 1100-2	45.0	60.0		77.0	76.0	74.0	71.0	69.0	63.0	58.0	54.0	49.0	42.0	32.0
SP 1100-3-AA	55.0	75.0		93.0	92.0	90.0	88.0	86.0	81.0	75.0	69.0	62.0	51.0	34.0
SP 1100-3-A	55.0	75.0		105.0	103.0	101.0	98.0	95.0	88.0	82.0	76.0	69.0	58.0	42.0
SP 1100-3	63.0	85.0		117.0	115.0	112.0	108.0	104.0	96.0	89.0	82.0	76.0	66.0	51.0
SP 1100-4-AA	75.0	100.0		133.0	131.0	128.0	125.0	122.0	114.0	106.0	98.0	88.0	74.0	53.0
SP 1100-4-A	75.0	100.0		144.0	142.0	139.0	135.0	130.0	121.0	112.0	104.0	94.0	81.0	60.0
SP 1100-4	75.0	100.0		155.0	152.0	149.0	144.0	139.0	128.0	118.0	110.0	100.0	87.0	68.0
SP 1100-5-AA	93.0	125.0		170.0	168.0	165.0	160.0	155.0	144.0	134.0	124.0	112.0	94.0	68.0
SP 1100-5-A	93.0	125.0		181.0	179.0	175.0	170.0	164.0	152.0	140.0	130.0	118.0	101.0	76.0
SP 1100-5	93.0	125.0		192.0	189.0	184.0	179.0	172.0	159.0	146.0	135.0	124.0	107.0	83.0
SP 1100-6-AA	110.0	150.0		209.0	206.0	202.0	197.0	191.0	178.0	164.0	152.0	138.0	117.0	86.0
SP 1100-6-A	110.0	150.0		220.0	217.0	212.0	206.0	199.0	184.0	170.0	158.0	143.0	123.0	93.0
SP 1100-6	110.0	150.0		231.0	228.0	223.0	216.0	207.0	191.0	177.0	164.0	149.0	129.0	101.0
SP 1100-7-AA	132.0	175.0		251.0	248.0	243.0	236.0	229.0	213.0	198.0	184.0	167.0	143.0	108.0
SP 1100-7-A	132.0	175.0		262.0	259.0	253.0	246.0	238.0	220.0	204.0	189.0	173.0	149.0	116.0
SP 1100-7	132.0	175.0		274.0	270.0	264.0	255.0	246.0	227.0	210.0	196.0	180.0	156.0	124.0
SP 1100-8-AA	147.0	200.0	292.0	288.0	282.0	274.0	266.0	247.0	230.0	213.0	195.0	168.0	128.0	
SP 1100-8-A	147.0	200.0	303.0	299.0	293.0	284.0	275.0	255.0	236.0	219.0	201.0	174.0	136.0	
SP 1100-8	147.0	200.0	315.0	310.0	303.0	294.0	284.0	262.0	243.0	225.0	207.0	181.0	144.0	
SP 1100-9-AA	170.0	230.0	331.0	327.0	320.0	312.0	302.0	281.0	260.0	242.0	221.0	191.0	146.0	
SP 1100-9-A	170.0	230.0	343.0	338.0	331.0	321.0	311.0	288.0	267.0	248.0	227.0	197.0	155.0	
SP 1100-9	170.0	230.0	354.0	349.0	341.0	331.0	319.0	295.0	273.0	254.0	233.0	204.0	162.0	

Dimensions and Weights

Pump Type	Motor Dia.	Dimensions (mm)				Net Weight (kg)
		A	B	C*	C**	
SP 1100-1-A	6"	771.7	Rp 6" NPT 6"	237	241	46.1
SP 1100-1	6"	771.7		237	241	46.1
SP 1100-2-AA	6"	947.7		237	241	56.1
SP 1100-2-A	6"	947.7		237	241	56.1
SP 1100-2	8"	947.7		237	241	55.8
SP 1100-3-AA	8"	1123.7		237	241	65.6
SP 1100-3-A	8"	1123.7		237	241	65.6
SP 1100-3	8"	1123.7		237	241	65.6
SP 1100-4-AA	8"	1299.7		237	241	75.4
SP 1100-4-A	8"	1299.7		237	241	75.4
SP 1100-4	8"	1299.7		237	241	75.4
SP 1100-5-AA	8"	1475.7		237	241	85.8
SP 1100-5-A	8"	1475.7		237	241	85.8
SP 1100-5	8"	1475.7		237	241	85.8
SP 1100-6-AA	8"	1651.7		237	241	96.2
SP 1100-6-A	8"	1651.7		237	241	96.2
SP 1100-6	8"	1651.7		237	241	96.2
SP 1100-7-AA	10"	1827.7		262	274	111.2
SP 1100-7-A	10"	1827.7		262	274	111.2
SP 1100-7	10"	1827.7		262	274	111.2
SP 1100-8-AA	10"	2003.7	262	274	121.5	
SP 1100-8-A	10"	2003.7	262	274	121.5	
SP 1100-8	10"	2003.7	262	274	121.5	
SP 1100-9-AA	10"	2179.7	262	274	131.7	
SP 1100-9-A	10"	2179.7	262	274	131.7	
SP 1100-9	10"	2179.7	262	274	131.7	

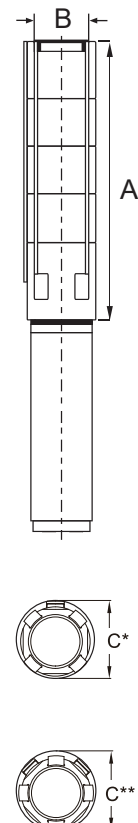

C* : Maximum diameter of pump with one motor cable
 C** : Maximum diameter of pump with two motor cable



www.sistema-pumps.com