



SP Stainless Steel Submersible Pumps

Made in Taiwan



Catalogue 60 Hz



SP Series

Index

General Data

Performance Range	2
Material Specification	3
4" Submersible Pumps	7
6" Submersible Pumps	8
8" Submersible Pumps	9
10" Submersible Pumps	10

Performance Curves/Technical Data

Series SP05	11
Series SP10	13
Series SP18	15
Series SP25	17
Series SP40	19
Series SP70	21
Series SP90	23
Series SP150	25
Series SP230	27
Series SP300	29
Series SP400	31
Series SP500	33
Series SP650	35
Series SP800	37
Series SP1100	39



SP Series 4", 6", 8", 10" Stainless Steel Submersible Pumps

SP4", 6", 8" and 10" submersible pumps are made of corrosion and abrasion resistant stainless steel and have been developed in accordance with state-of-the-art technology. The SP series of pumps are manufactured to the highest standards for energy efficiency, dependable performance, rugged construction and long service life for the most demanding applications.

General Data

Performance range

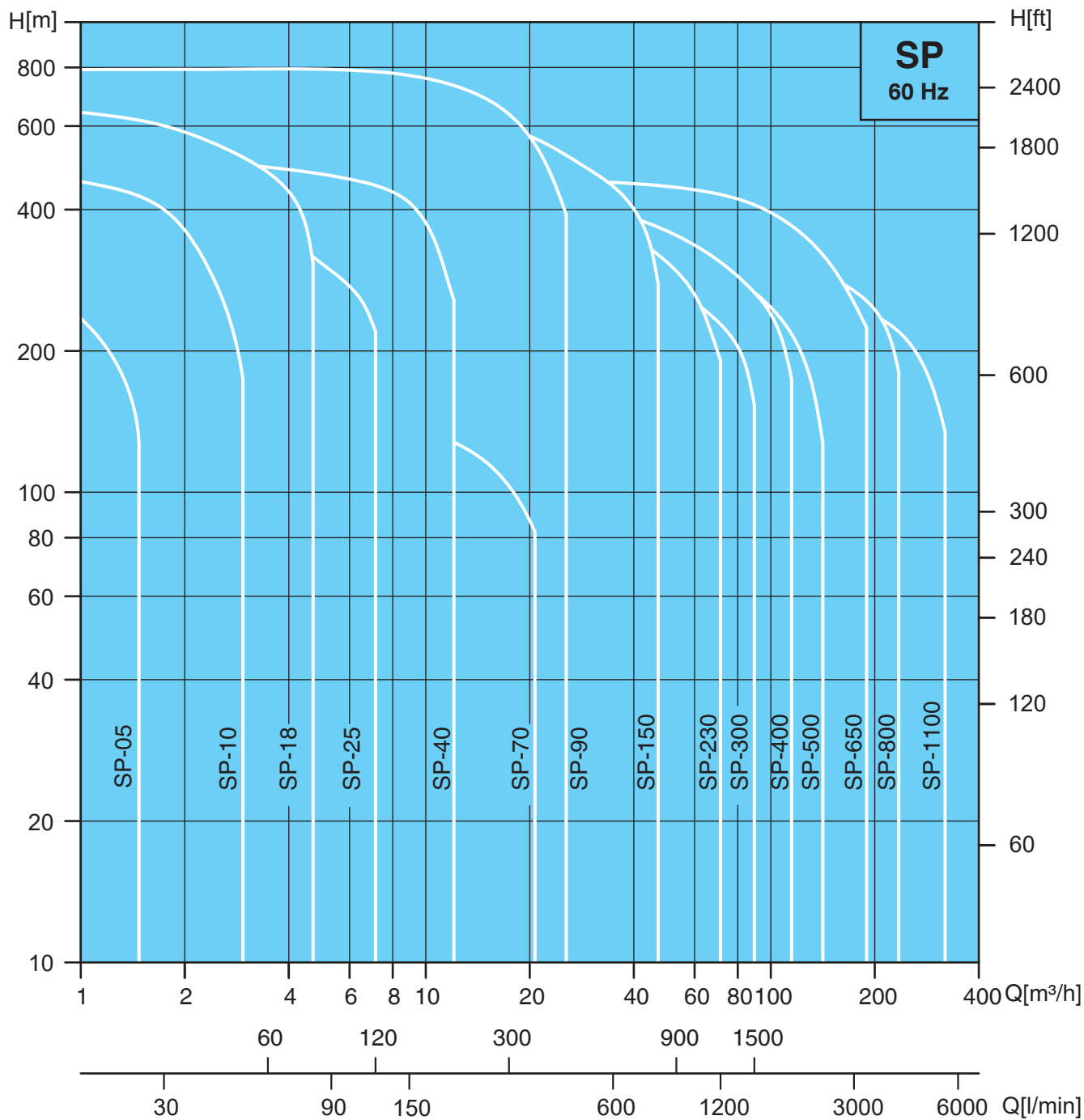

General Data

Example: SP-70

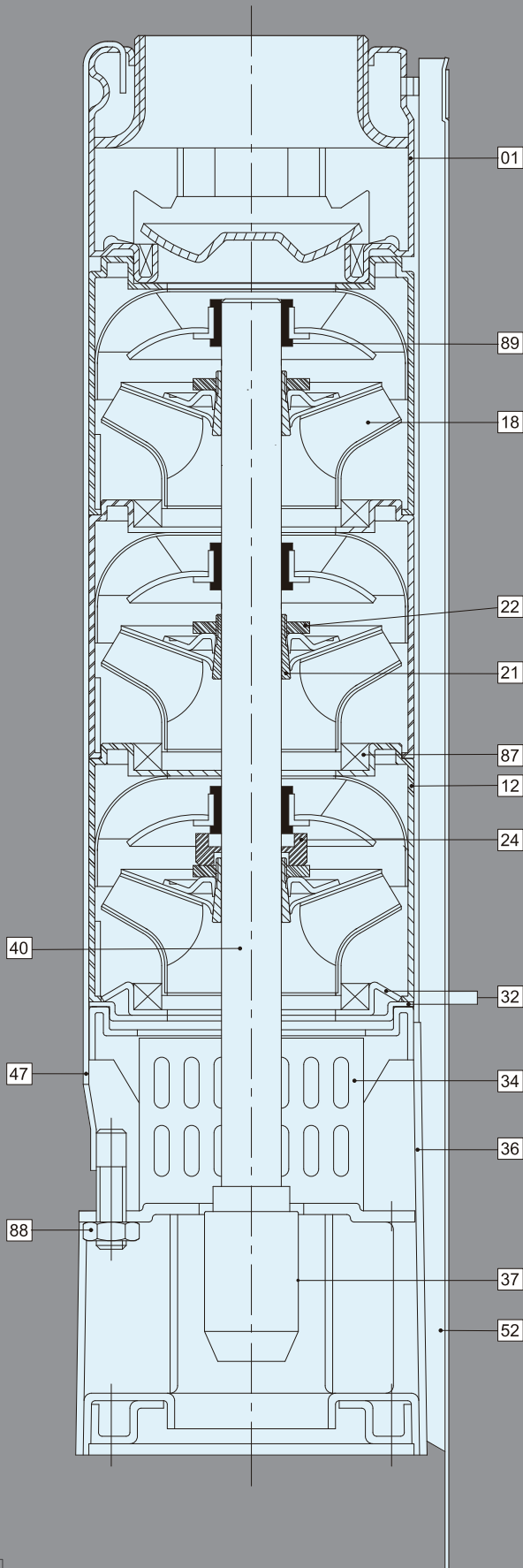

Material Specification-4" Pumps

Pos.	Components	Standard
01	Discharge	SUS304 / SUS316
12	Diffuser	SUS304 / SUS316
18	Impeller	SUS304 / SUS316
21	Split Cone	SUS304 / SUS316
22	Split Cone Nut	SUS304 / SUS316
24	Stop Ring	Carbon+Graphite+PTFE
32	Neck Ring Retainer	SUS304 / SUS316
34	Strainer	SUS304 / SUS316
36	Suction Interconnector	SUS304 / SUS316
37	Coupling	SUS304 / SUS316
40	Pump Shaft	SUS304 / SUS431 / SUS316
47	Strap	SUS304 / SUS316
52	Cable Guard	SUS304 / SUS316
87	Neck Ring	SUS304+NBR / HNBR
88	Nut	SUS304 / SUS316
89	Bearing	NBR / HNBR

*AISI 316 stainless steel pumps are available on request.

General Data

Example: SP-90

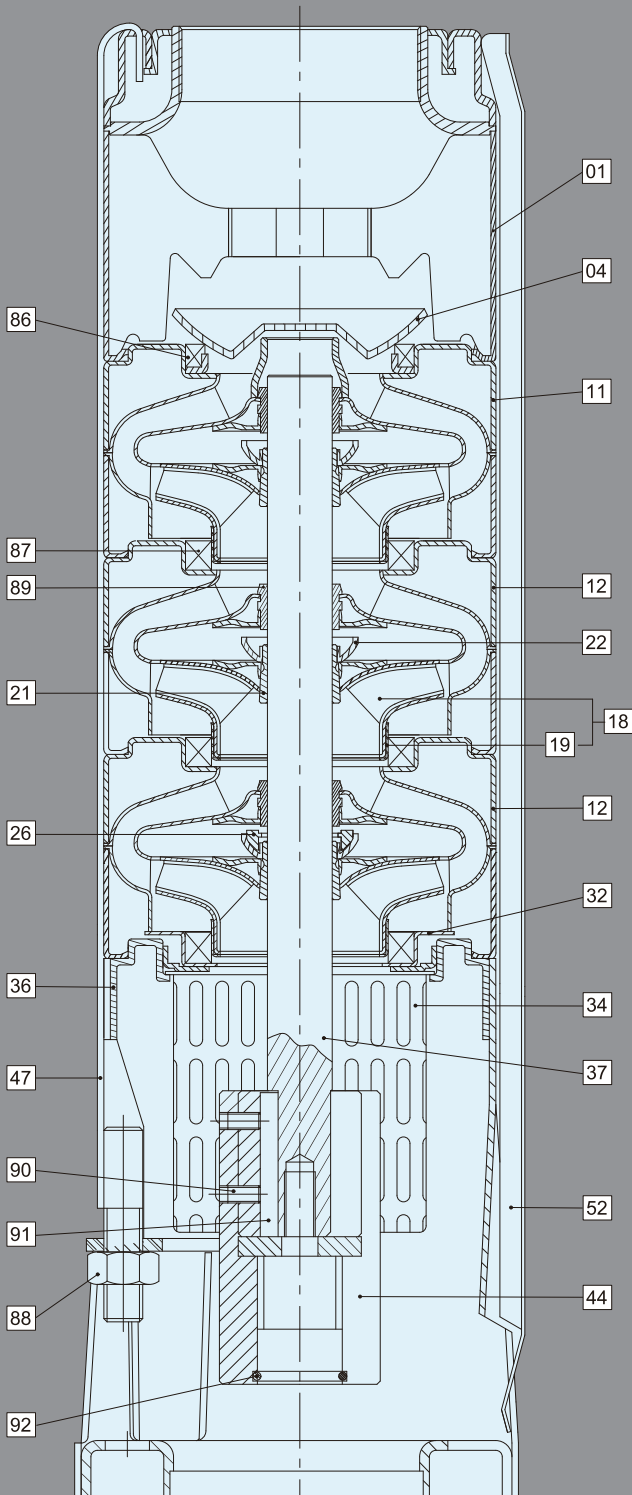

Material Specification-6" Pumps

Pos.	Components	Standard
01	Discharge	SUS304 / SUS316
04	Valve Cone	SUS304 / SUS316
11	Top Diffuser	SUS304 / SUS316
12	Diffuser	SUS304 / SUS316
18	Impeller	SUS304 / SUS316
19	Ring of Impeller	SUS304 / SUS316
21	Split Cone	SUS304 / SUS316
22	Split Cone Nut	SUS304 / SUS316
26	Spacing Washer For Stop Ring	Carbon+Graphite+PTFE
32	Neck Ring Retainer	SUS304 / SUS316
34	Strainer	SUS304 / SUS316
36	Suction Interconnector	SUS304 / SUS316
37	Pump Shaft	SUS431 / SUS316
44	Coupling	SUS431 / SUS316
47	Strap	SUS304 / SUS316
52	Cable Guard	SUS304 / SUS316
86	Valve Seat	SUS304+NBR / HNBR
87	Neck Ring	SUS304+NBR / HNBR
88	Nut	SUS304 / SUS316
89	Bearing	NBR / HNBR
90	Screw	SUS304 / SUS316
91	Key	SUS304 / SUS316
92	O-ring	NBR / HNBR

*AISI 316 stainless steel pumps are available on request.

General Data

Example: SP500

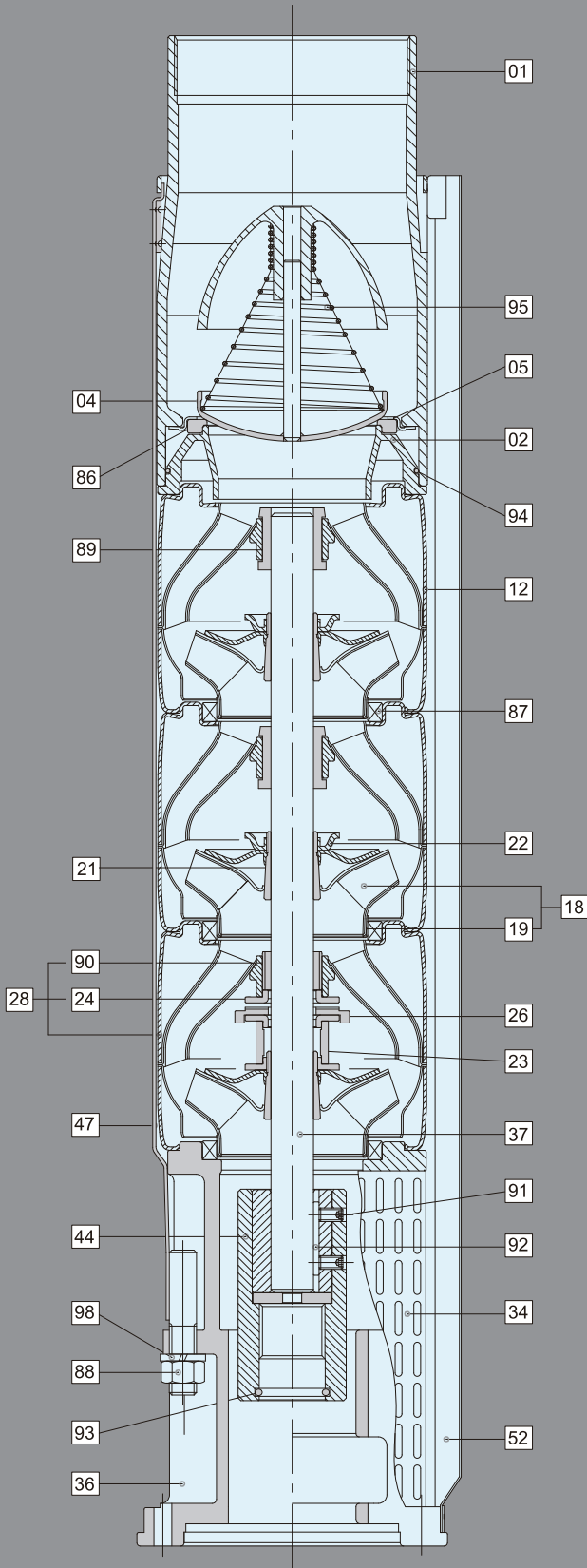

Material Specification-8" Pumps

Pos.	Components	Standard
01	Discharge	SUS304 / SUS316
02	Lower Valve Seat Retainer	SUS304 / SUS316
04	Valve Cup	SUS304 / SUS316
05	Upper Valve Seat Retainer	SUS304 / SUS316
12	Diffuser	SUS304 / SUS316
18	Impeller	SUS304 / SUS316
19	Ring Of Impeller	SUS304 / SUS316
21	Split Cone	SUS304 / SUS316
22	Split Cone Nut	SUS304 / SUS316
23	Nut For Stop Ring	SUS304 / SUS316
24	Stop Ring	SUS304 / SUS316
26	Spacing Washer For Stop Ring	Carbon+Graphite+PTFE
28	Bottom Diffuser	SUS304 / SUS316
34	Strainer	SUS304 / SUS316
36	Suction Interconnector	SUS304 / SUS316
37	Pump Shaft	SUS431 / SUS316
44	Coupling	SUS304 / SUS316
47	Strap	SUS304 / SUS316
52	Cable Guard	SUS304 / SUS316
86	Valve Seat	NBR / HNBR
87	Neck Ring	SUS304+NBR / SUS316+HNBR
88	Nut	SUS304 / SUS316
89	Bearing	NBR / HNBR
90	Bearing	US304+NBR / SUS316+HNBR
91	Screw	SUS304 / SUS316
92	Key	SUS304 / SUS316
93	O-ring	NBR / HNBR
94	O-ring	NBR / HNBR
95	Spring	SUS304 / SUS316
98	Spring Washer	SUS304 / SUS316

*AISI 316 stainless steel pumps are available on request.

General Data

Example: SP-1100

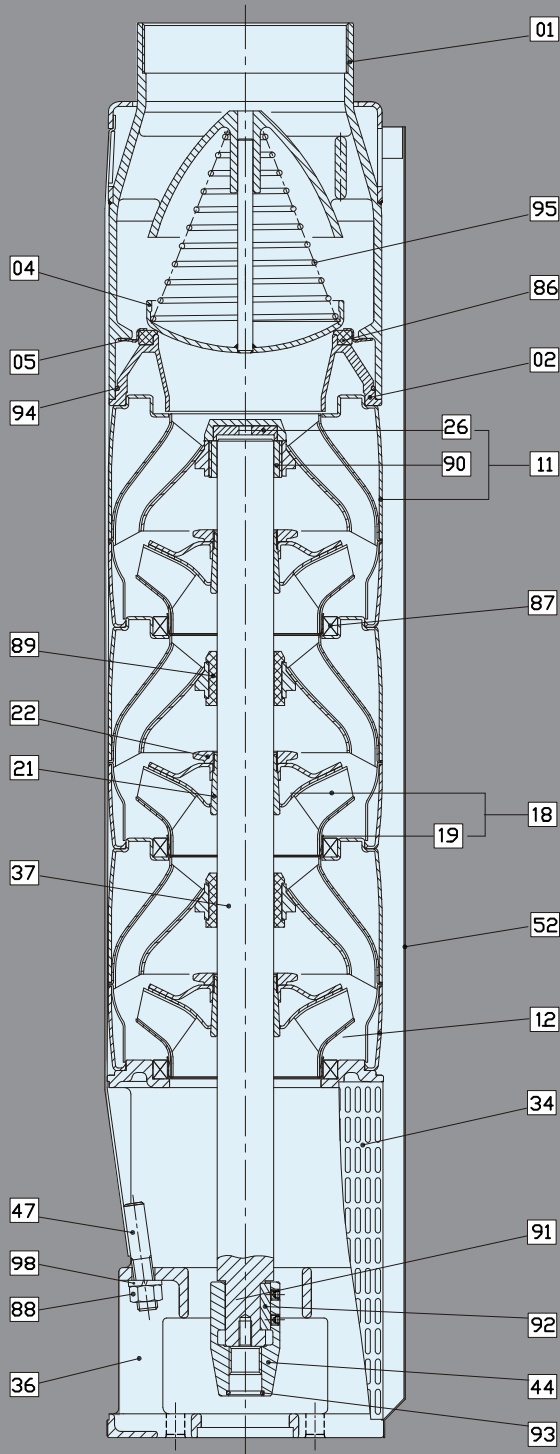

Material Specification-10" Pumps

Pos.	Components	Standard
01	Discharge	SUS304 / SUS316
02	Lower Valve Seat Retainer	SUS304 / SUS316
04	Valve Cup	SUS304 / SUS316
05	Upper Valve Seat Retainer	SUS304 / SUS316
11	Upper Diffuser	SUS304 / SUS316
+26	Spacing Washer For Stop Ring	Carbon Fiber+MoS2+PTFE
+90	Upper Bearing	SUS304+NBR60 / SUS316+HNBR
12	Diffuser	SUS304 / SUS316
18	Impeller	SUS304 / SUS316
18	Impeller - A	SUS304 / SUS316
+19	Ring Of Impeller	SUS304 / SUS316
21	Split Cone	SUS304 / SUS316
22	Split Cone Nut	SUS304 / SUS316
34	Strainer - one lead	SUS304 / SUS316
34	Strainer - two leads	SUS304 / SUS316
36	Suction Interconnector - 6"	SUS304 / SUS316
36	Suction Interconnector - 8"	SUS304 / SUS316
37	Shaft	SUS431 / SUS316
44	Coupling - 6"	SUS304 / SUS316
44	Coupling - 8"	SUS304 / SUS316
47	Strap	SUS304 / SUS316
52	Cable Guard	SUS304 / SUS316
86	Valve Seat	NBR70 / HNBR70
87	Neck Ring	PPS+NBR / HNBR
88	Nut	SUS304 / SUS316
89	Bearing	NBR70 / HNBR70
91	Screw - 6"	SUS304 / SUS316
91	Screw - 8"	SUS304 / SUS316
92	Key - 6"	SUS304 / SUS316
92	Key - 8"	SUS304 / SUS316
93	O-ring - 6"	NBR70 / HNBR70
93	O-ring - 8"	NBR70 / HNBR70
94	O-ring	NBR70 / HNBR70
95	Spring	SUS304 / SUS316
98	Spring Washer	SUS304 / SUS316

*AISI 316 stainless steel pumps are available on request.

General Data

4" Stainless Steel Submersible Pumps

SP 4" range of submersible pumps are made of corrosion and abrasion resistant stainless steel and have been developed in accordance with state of the art technology. The SP 4" pumps are manufactured to the highest standards of highly efficient hydraulic impeller and diffuser design to reach high energy efficiency, dependable performance, rugged construction and long service life, even in difficult environments.

Applications

- ◆ Potable water supply
- ◆ Agricultural irrigation and livestock watering
- ◆ Municipal and industrial water supply
- ◆ Pressure boosting
- ◆ Mining applications
- ◆ Groundwater lowering
- ◆ Fountain

Pumped Liquids

- ◆ Clean, thin, non-aggressive and non-corrosive liquids without solid particles or fibers.

Operating Conditions

- ◆ Capacity (m³/h) min 0.3 max 21
- ◆ Total Head: Max. 687 m
- ◆ Max. ambient temperature (Liquid): 50°C
- ◆ Sand content: Max. 50 g/m³
- ◆ Screen size of each hole:

5 x 1 mm (SP-05~10) 

Ø2.5 mm (SP-18~25) 

20 x 4 mm (SP-40~70) 

Features

- ◆ Stainless steel construction designed and built for years of trouble free operation
- ◆ Designed and built to operate in difficult conditions.
- ◆ All metal parts are made of 304 or 316 stainless steel, except for the shafts, which are made of 431, 304 or 316 stainless steel.
- ◆ Heavy duty stainless steel discharge head with built-in check valve for preventing back flow in connection with pump stoppage and the risk of destructive water hammer is reduced to a minimum.
- ◆ Smooth safety hook.
- ◆ NEMA standard of bracket mounting.
- ◆ High quality shaft bearings provide low friction and high wear resistance.
- ◆ The stop ring prevents damage to the pump during transport and in case of up-thrust in connection with start-up. The stop ring, which is designed as a thrust bearing, limits axial movements of the pump shaft.
- ◆ Stainless steel strainer to restrict the entry of sand and other extraneous material.

Model code

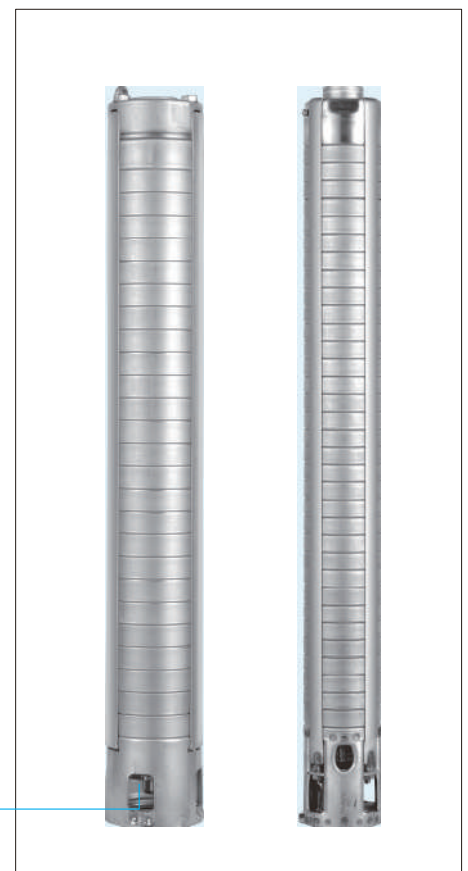
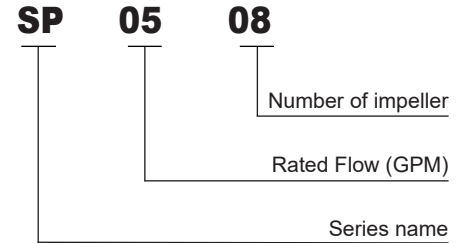

6" Stainless Steel Submersible Pumps

SP 6" range of submersible pumps are made of corrosion and abrasion resistant stainless steel and have been developed in accordance with state of the art technology. The SP 6" pumps are manufactured to the highest standards of highly efficient hydraulic impeller and diffuser design to reach high energy efficiency, dependable performance, rugged construction and long service life, even in difficult environments.

Applications

- ◆ Potable water supply
- ◆ Agricultural irrigation and livestock watering
- ◆ Municipal and industrial water supply
- ◆ Pressure boosting
- ◆ Mining applications
- ◆ Groundwater lowering
- ◆ Fountain

Pumped Liquids

- ◆ Clean, thin, non-aggressive and non-corrosive liquids without solid particles or fibers.

Operating Conditions

- ◆ Capacity (m³/h) min 6 max 90
- ◆ Total Head: Max. 794 m
- ◆ Max. ambient temperature (Liquid): 50°C
- ◆ Sand content: Max. 50 g/m³
- ◆ Screen size of each hole: 20 x 4 mm



Model code

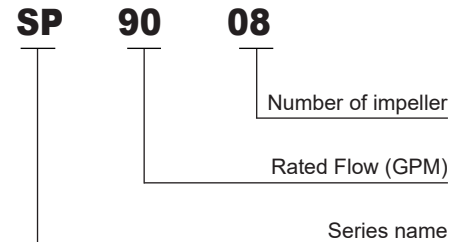

Features

- ◆ Stainless steel construction designed and built for years of trouble free operation
- ◆ Designed and built to operate in difficult conditions.
- ◆ All metal parts are made of 304 or 316 stainless steel, except for the shafts, which are made of 431 or 316 stainless steel.
- ◆ Heavy duty stainless steel discharge head with built-in check valve for preventing back flow in connection with pump stoppage and the risk of destructive water hammer is reduced to a minimum.
- ◆ NEMA standard of bracket mounting.
- ◆ High quality shaft bearings provide low friction and high wear resistance.
- ◆ The stop ring prevents damage to the pump during transport and in case of up-thrust in connection with start-up. The stop ring, which is designed as a thrust bearing, limits axial movements of the pump shaft.
- ◆ Stainless steel strainer to restrict the entry of sand and other extraneous material.

General Data

8" Stainless Steel Submersible Pumps

SP 8" range of submersible pumps are made of corrosion and abrasion resistant stainless steel and have been developed in accordance with state of the art technology, which is also for heavy duty and high volume pumping application. The SP 8" pumps are manufactured to the highest standards of highly efficient hydraulic impeller and diffuser design to reach high energy efficiency, dependable performance, rugged construction and long service life, even in difficult environments.

Applications

- ◆ Potable water supply
- ◆ Agricultural irrigation and livestock watering
- ◆ Municipal and industrial water supply
- ◆ Pressure boosting
- ◆ Mining applications
- ◆ Groundwater lowering
- ◆ Fountain

Pumped Liquids

- ◆ Clean, thin, non-aggressive and non-corrosive liquids without solid particles or fibers.

Operating Conditions

- ◆ Capacity (m³/h) min 18 max 150
- ◆ Total Head: Max. 440 m
- ◆ Max. ambient temperature (Liquid):50°C
- ◆ Sand content: Max. 50 g/m³

Screen size of each hole: 20 x 4 mm



Model code

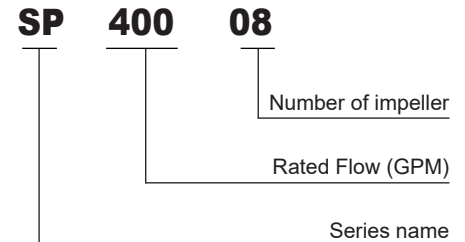

Features

- ◆ Stainless steel construction designed and built for years of trouble free operation
- ◆ Designed and built to operate in difficult conditions.
- ◆ All metal parts are made of 304 or 316 stainless steel, except for the shafts, which are made of 431 or 316 stainless steel.
- ◆ Heavy duty stainless steel discharge head with built-in check valve for preventing back flow in connection with pump stoppage and the risk of destructive water hammer is reduced to a minimum.
- ◆ NEMA standard of bracket mounting.
- ◆ High quality shaft bearings provide low friction and high wear resistance.
- ◆ The stop ring prevents damage to the pump during transport and in case of up-thrust in connection with start-up. The stop ring, which is designed as a thrust bearing, limits axial movements of the pump shaft.
- ◆ Stainless steel strainer to restrict the entry of sand and other extraneous material.

10" Stainless Steel Submersible Pumps

SP 10" range of submersible pumps are made of corrosion and abrasion resistant stainless steel and have been developed in accordance with state of the art technology, which is also for heavy duty and high volume pumping application. The SP 10" pumps are manufactured to the highest standards of highly efficient hydraulic impeller and diffuser design to reach high energy efficiency, dependable performance, rugged construction and long service life, even in difficult environments.

Model code

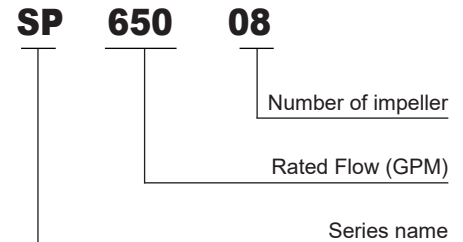

Applications

- ◆ Potable water supply
- ◆ Agricultural irrigation and livestock watering
- ◆ Municipal and industrial water supply
- ◆ Pressure boosting
- ◆ Mining applications
- ◆ Groundwater lowering
- ◆ Fountain

Pumped Liquids

- ◆ Clean, thin, non-aggressive and non-corrosive liquids without solid particles or fibers.

Operating Conditions

- ◆ Capacity (m³/h) min 20 max 335
- ◆ Total Head: Max. 471 m
- ◆ Max. ambient temperature (Liquid): 50°C
- ◆ Sand content: Max. 50 g/m³

Screen size of each hole: 20 x 4 mm



Features

- ◆ Stainless steel construction designed and built for years of trouble free operation
- ◆ Designed and built to operate in difficult conditions.
- ◆ All metal parts are made of 304 or 316 stainless steel, except for the shafts, which are made of 431 or 316 stainless steel.
- ◆ Heavy duty stainless steel discharge head with built-in check valve for preventing back flow in connection with pump stoppage and the risk of destructive water hammer is reduced to a minimum.
- ◆ High quality shaft bearings provide low friction and high wear resistance.
- ◆ The stop ring prevents damage to the pump during transport and in case of up-thrust in connection with start-up. The stop ring, which is designed as a thrust bearing, limits axial movements of the pump shaft.
- ◆ Stainless steel strainer to restrict the entry of sand and other extraneous material.

SP Series

SP 4"

SP05 Performance Curves

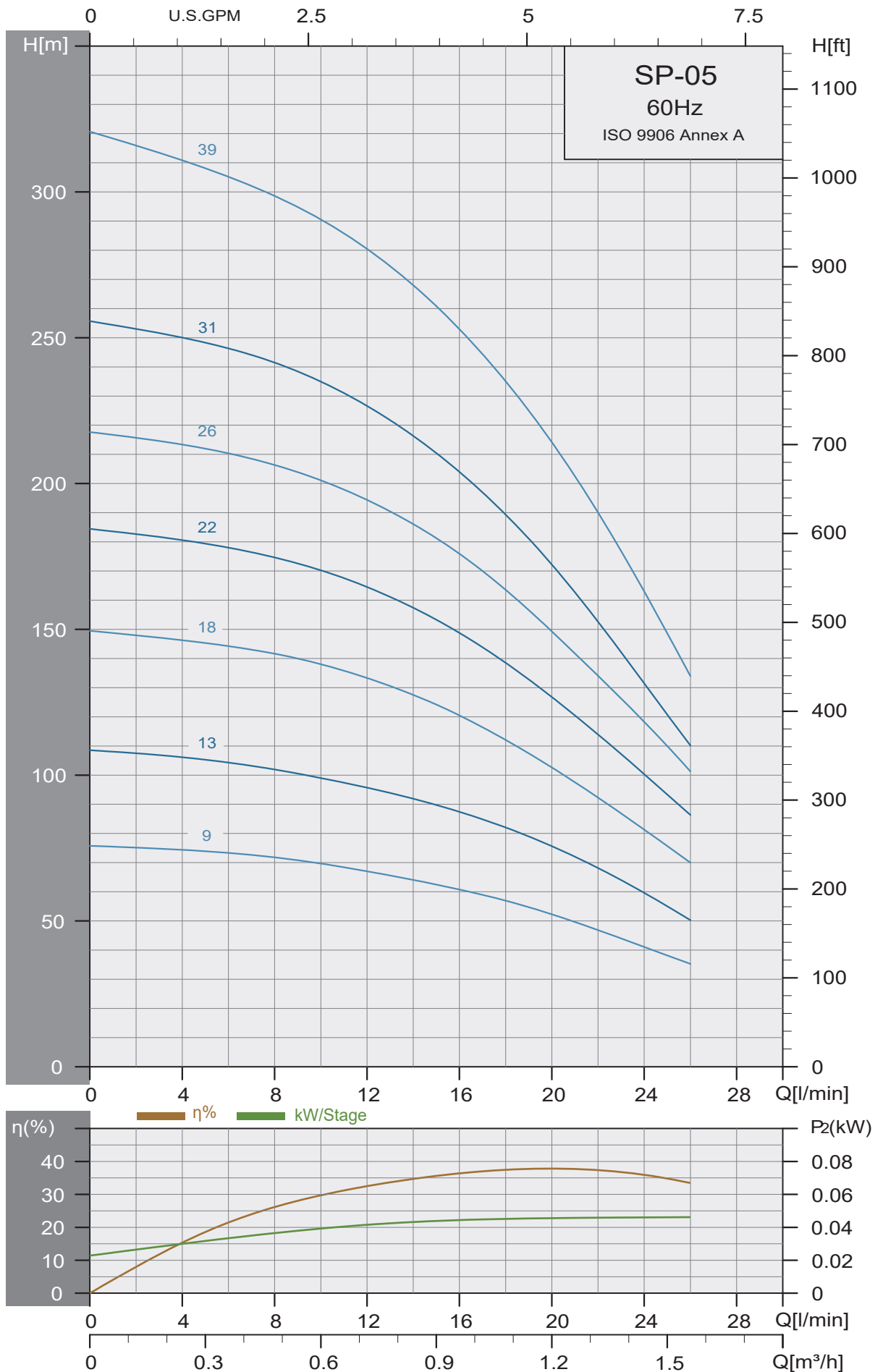

Selection Chart

60Hz

Pump Type	Motor		Q capacity 3450 rpm						
	P2		l/min	0	5	10	15	20	25
	KW	HP	m³/h	0	0.3	0.6	0.9	1.2	1.5
SP-0509	0.25	0.33	HEAD IN METERS	76	74	70	62	52	38
SP-0513	0.37	0.5		108	105	99	90	76	55
SP-0518	0.55	0.75		150	145	138	124	102	75
SP-0522	0.75	1		183	179	170	153	127	93
SP-0526	1.1	1.5		218	212	201	181	149	110
SP-0531	1.1	1.5		256	248	235	210	172	121
SP-0539	1.5	2		320	308	291	261	214	148

*Higher pressure , longer stages pumps up to 39 stages are available on request.

Dimensions and weights

Pump Type	Motor Dia.	Dimensions (mm)		Net Weight (Kg) Pump
		A	C	
SP-0509	4"	356	98	2.9
SP-0513	4"	440	98	3.6
SP-0518	4"	545	98	4.4
SP-0522	4"	629	98	5.1
SP-0526	4"	713	98	5.8
SP-0531	4"	841	98	8.8
SP-0539	4"	1009	98	10.7

C= Maximum diameter of pump inclusive of cable guard and motor.

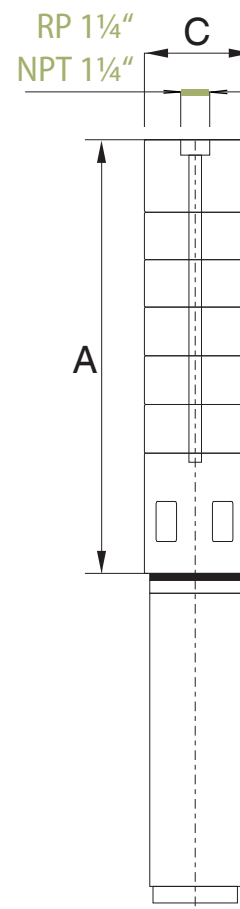

SP Series

SP 4"

SP10 Performance Curves

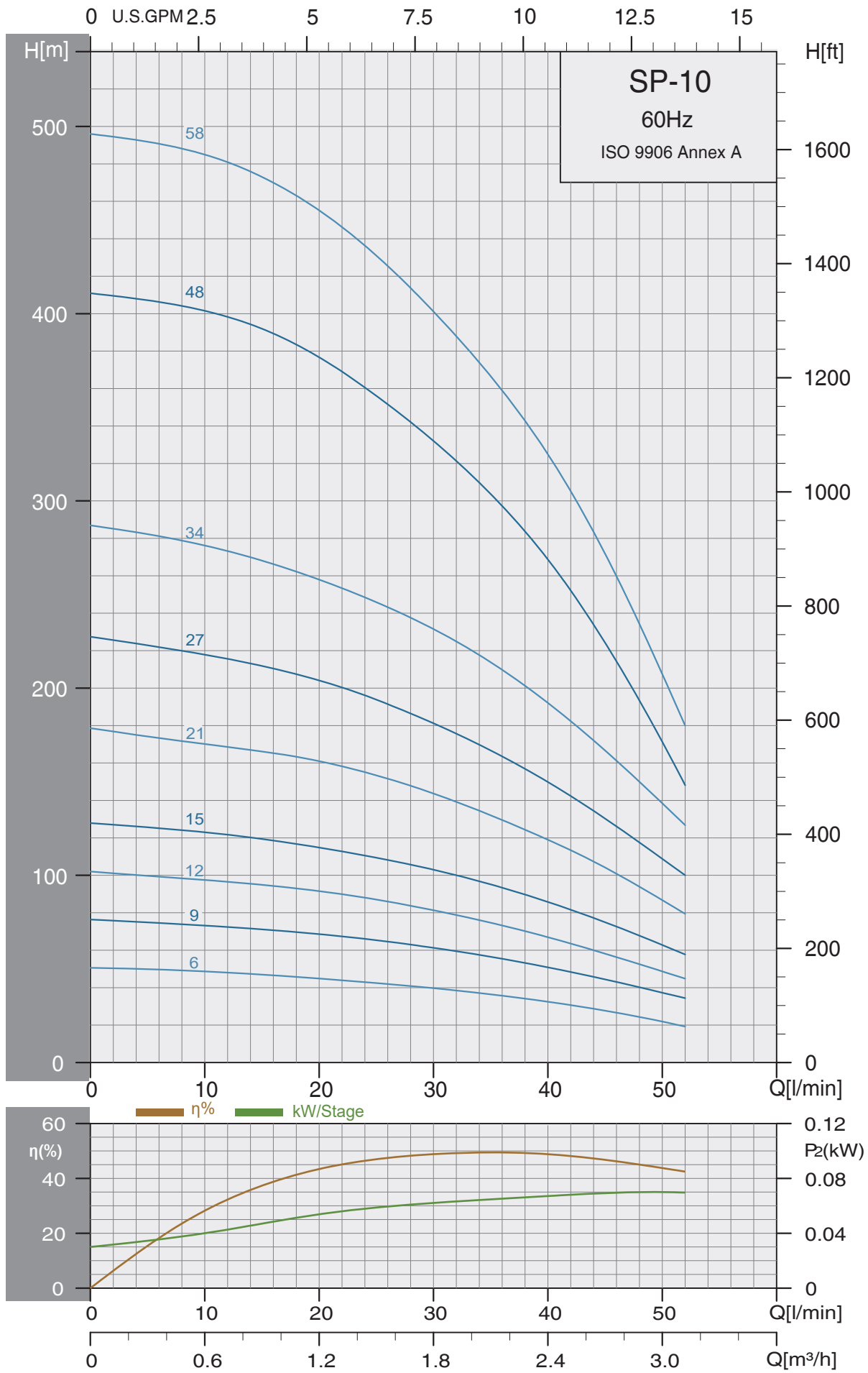

Selection Chart

60Hz

Pump Type	Motor		Q capacity 3450 rpm							
	P2		l/min m³/h	0	20	25	30	35	40	50
	KW	HP		0	1.2	1.5	1.8	2.1	2.4	3.0
SP-1006	0.25	0.33	HEAD IN METERS	51	45	42	40	36	32	21
SP-1009	0.37	0.5		77	69	65	61	56	51	37
SP-1012	0.55	0.75		102	92	87	81	75	67	49
SP-1015	0.75	1		128	115	109	103	95	86	63
SP-1021	1.1	1.5		179	160	153	144	132	119	87
SP-1027	1.5	2		227	204	194	181	167	150	109
SP-1034	2.2	3		287	258	246	231	214	192	138
SP-1048	4	5.5		411	376	356	331	303	268	171
▶ SP-1058	4	5.5		496	455	431	401	367	325	207

*Higher pressure , longer stages pumps up to 58 stages are available on request.

▶ With Sleeve .

Dimensions and weights

Pump Type	Motor Dia.	Dimensions (mm)		Net Weight (Kg) Pump
		A	C	
SP-1006	4"	293	98	2.4
SP-1009	4"	356	98	3
SP-1012	4"	419	98	3.6
SP-1015	4"	482	98	4.2
SP-1021	4"	608	98	5.3
SP-1027	4"	734	98	6.4
SP-1034	4"	904	98	10
SP-1048	4"	1198	98	11.5
▶ SP-1058	4"	1766	133	33.9

C = Maximum diameter of pump inclusive of cable guard and motor.
SP-1058 are mounted in sleeve for R 1 1/4 connection.

▶ With Sleeve .

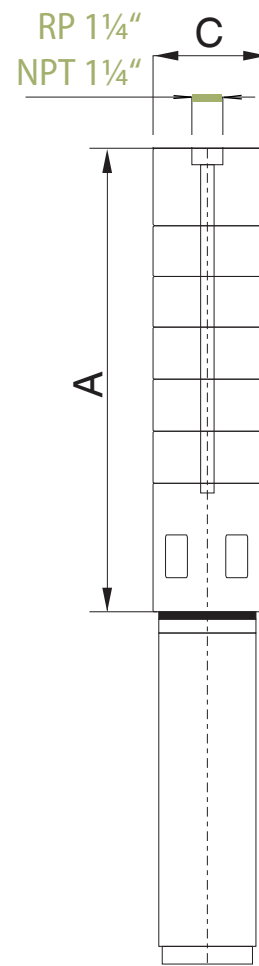

SP Series

SP 4"

SP18 Performance Curves

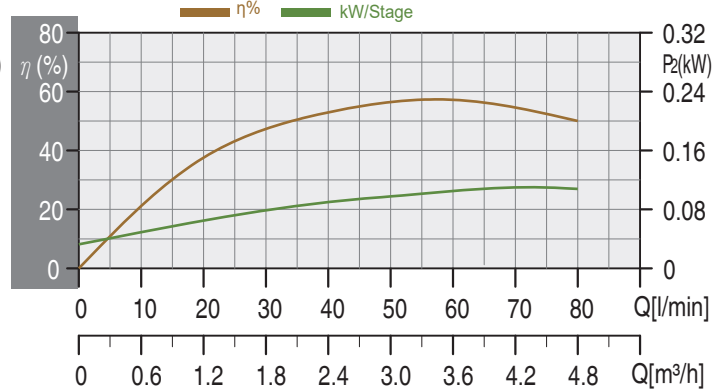
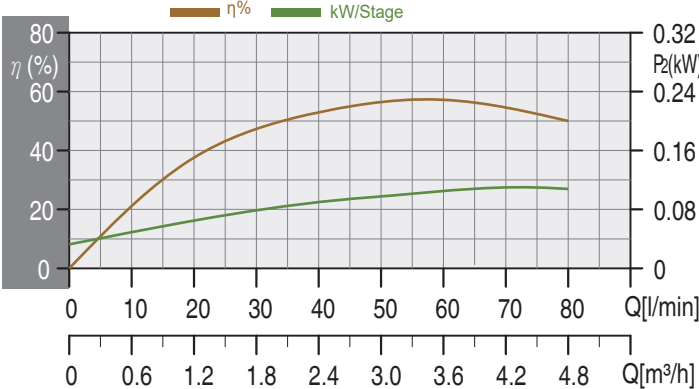
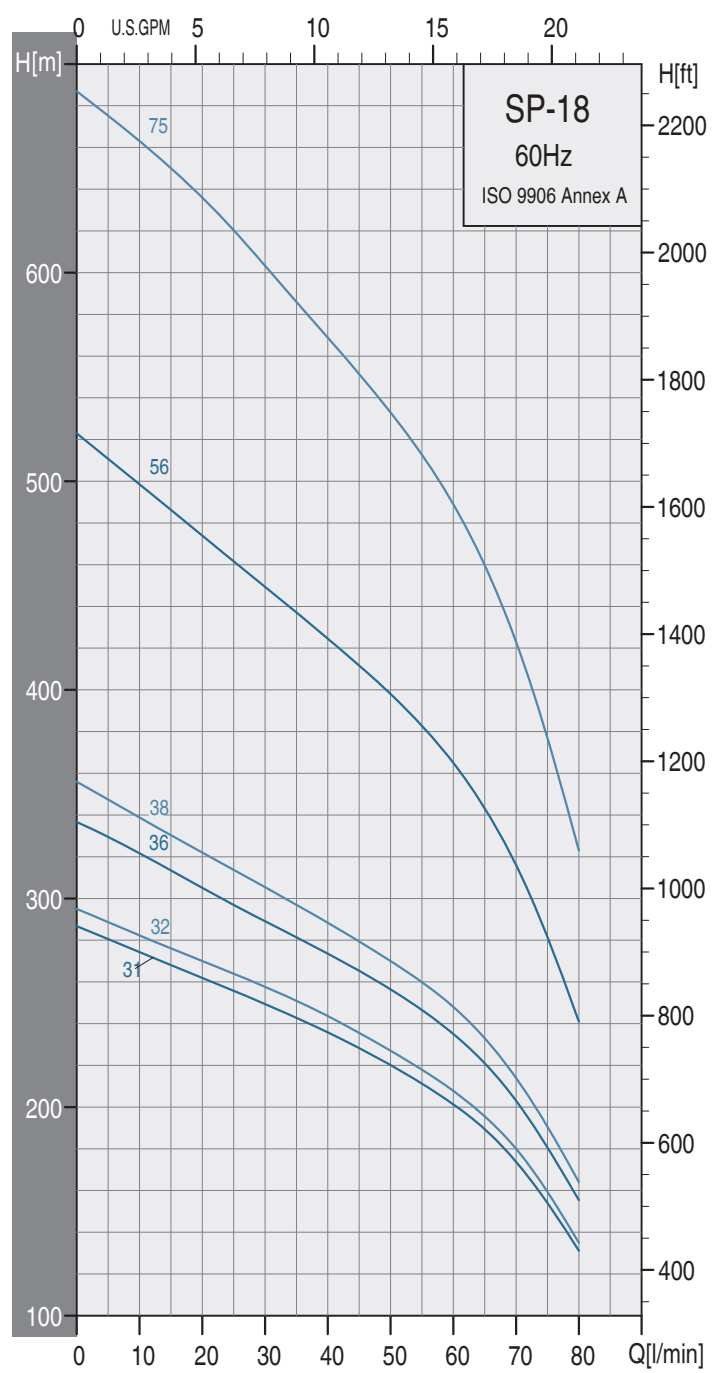
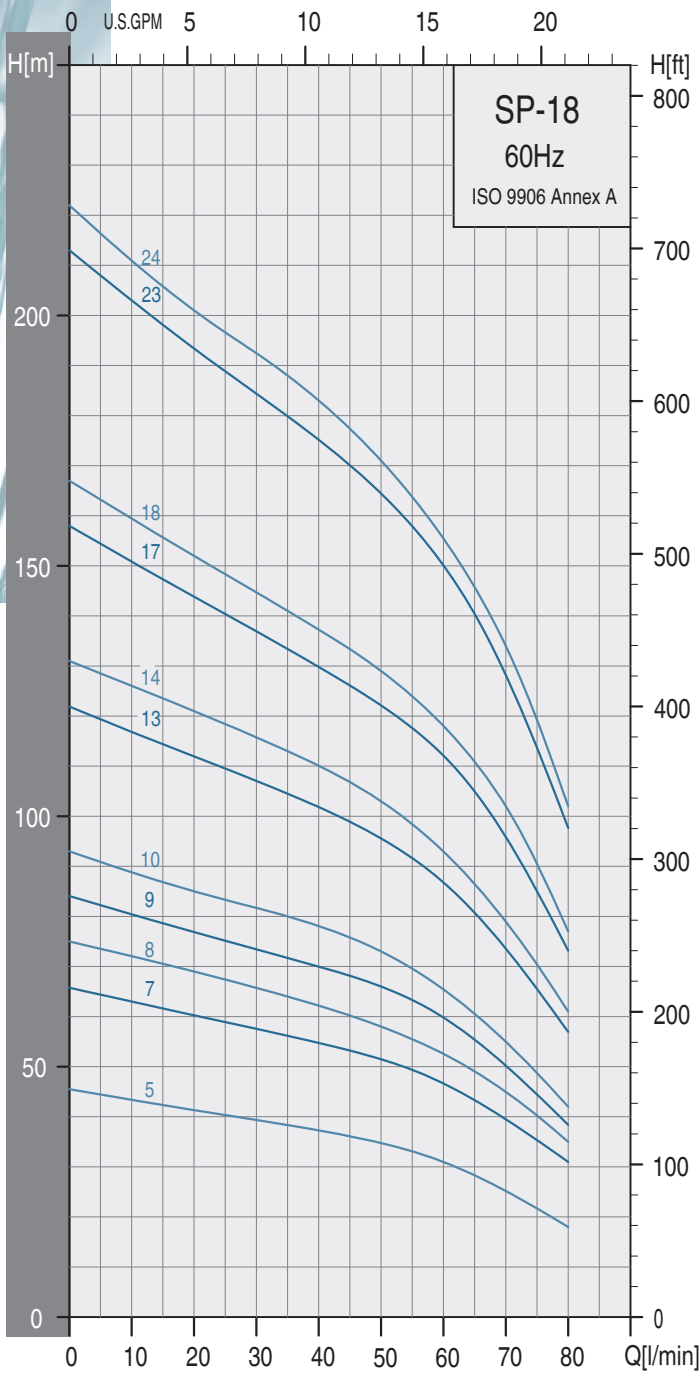

Selection Chart

60Hz

Pump Type	Motor		Q capacity 3450 rpm							
	P2		l/min m³/h	0	35	40	50	60	70	80
	KW	HP		0	2.1	2.4	3.0	3.6	4.2	4.8
SP-1805	0.37	0.5	HEAD IN METERS	46	38	37	35	31	25	18
SP-1807	0.55	0.75		66	56	55	51	47	39	31
SP-1808	0.75	1		75	64	63	58	54	45	35
SP-1809	0.75	1		84	72	70	66	60	50	38
SP-1810	0.75	1		93	80	77	73	66	55	42
SP-1813	1.1	1.5		122	105	102	96	87	73	57
SP-1814	1.1	1.5		131	113	110	103	94	79	61
SP-1817	1.5	2		158	133	130	122	112	96	73
SP-1818	1.5	2		167	141	138	129	119	102	77
SP-1823	2.2	3		213	180	175	164	150	128	98
SP-1824	2.2	3		222	188	183	171	157	134	102
SP-1831	3	4		286	243	236	220	201	174	131
SP-1832	3	4		295	251	244	227	207	180	135
SP-1836	3.7	5		337	281	274	256	235	203	155
SP-1838	3.7	5		356	297	287	270	248	214	164
▶ SP-1856	5.5	7.5		522	437	425	398	365	316	241
▶ SP-1875	7.5	10		687	586	569	533	489	423	323

*Higher pressure , longer stages pumps up to 75 stages are available on request.

▶ With Sleeve .

Dimensions and weights

Pump Type	Motor Dia.	Dimensions (mm)		Net Weight (Kg)
		A	C	Pump
SP-1805	4"	272	98	2.3
SP-1807	4"	314	98	2.6
SP-1808	4"	335	98	2.8
SP-1809	4"	356	98	3.0
SP-1810	4"	377	98	3.2
SP-1813	4"	440	98	3.8
SP-1814	4"	461	98	4.0
SP-1817	4"	524	98	4.5
SP-1818	4"	545	98	4.7
SP-1823	4"	650	98	5.7
SP-1824	4"	671	98	5.9
SP-1831	4"	841	98	9.2
SP-1832	4"	862	98	9.5
SP-1836	4"	946	98	10.5
SP-1838	4"	988	98	11
▶ SP-1856	4"	1724	133	34
▶ SP-1856	6"	1741	140	34
▶ SP-1875	6"	1951	140	41.8

▶ With Sleeve .

C = Maximum diameter of pump inclusive of cable guard and motor.
SP-1856 to SP-1875 are mounted in sleeve for R 1 1/4 connection.

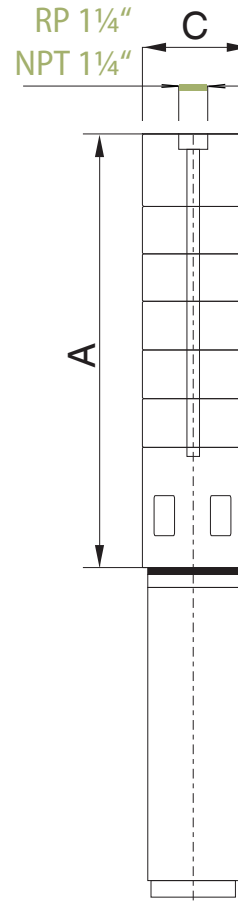

SP Series

SP 4"

SP25 Performance Curves

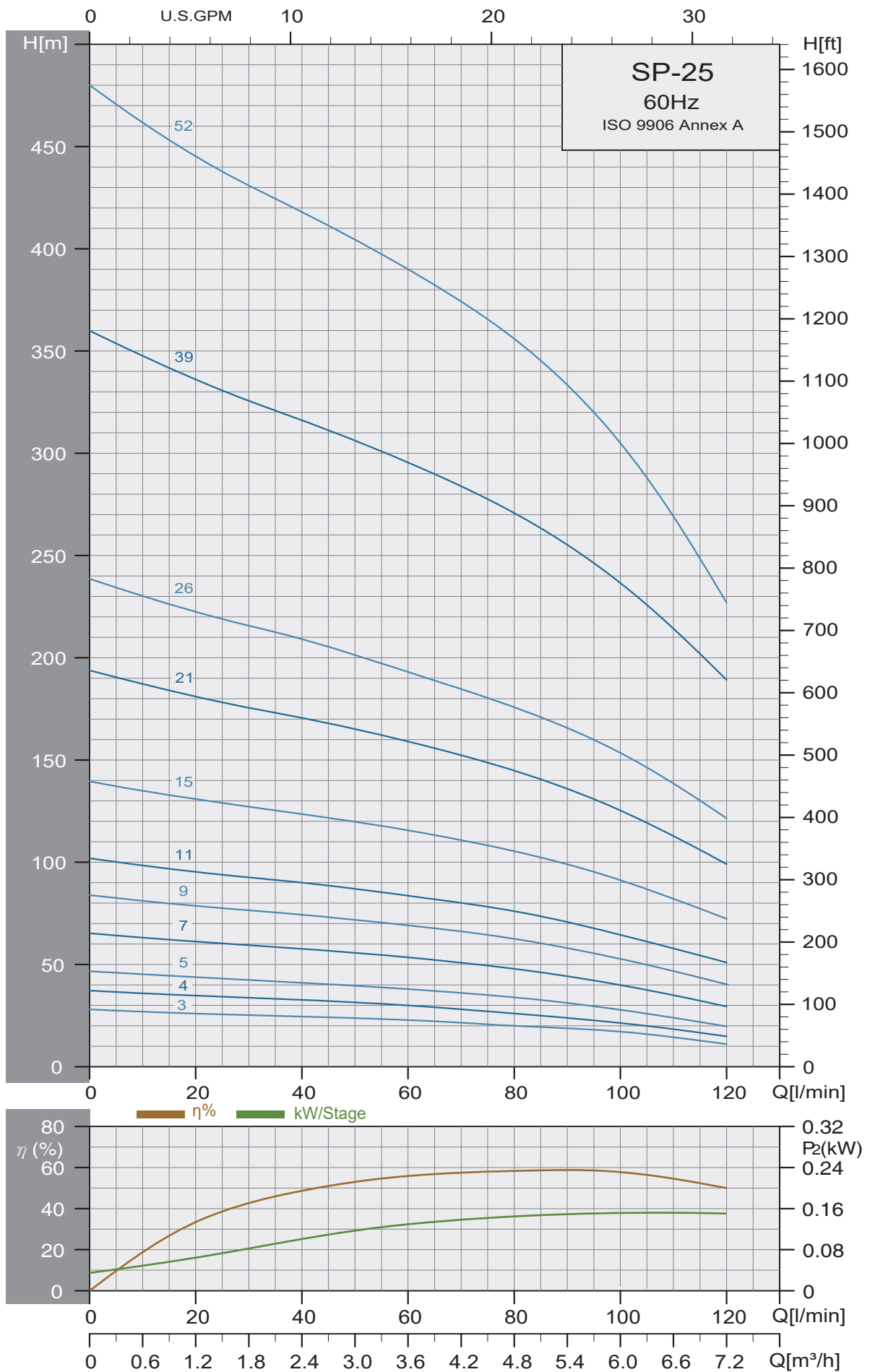

Selection Chart

60Hz

Pump Type	Motor		Q capacity 3450 rpm							
	P2		l/min m³/h	0	60	70	80	90	100	120
	KW	HP		0	3.6	4.2	4.8	5.4	6.0	7.2
SP-2503	0.37	0.5	HEAD IN METERS	28	23	21	20	18	17	11
SP-2504	0.37	0.5		37	30	28	26	24	23	15
SP-2505	0.55	0.75		47	38	36	34	31	28	20
SP-2507	0.75	1		65	53	51	48	44	40	29
SP-2509	1.1	1.5		84	69	66	63	58	53	40
SP-2511	1.5	2		102	84	80	76	71	65	51
SP-2515	2.2	3		140	116	111	105	99	91	72
SP-2521	3	4		194	259	152	145	136	125	99
SP-2526	3.7	5		237	193	185	176	166	153	122
SP-2539	5.5	7.5		360	295	284	271	255	237	189
▶ SP-2552	7.5	10		480	390	374	356	333	305	227

*Higher pressure , longer stages pumps up to 52 stages are available on request.

▶ With Sleeve .

Dimensions and weights

Pump Type	Motor Dia.	Dimensions (mm)		Net Weight (Kg) Pump
		A	C	
SP-2503	4"	230	98	1.8
SP-2504	4"	251	98	2.0
SP-2505	4"	272	98	2.2
SP-2507	4"	314	98	2.6
SP-2509	4"	356	98	3.0
SP-2511	4"	398	98	3.4
SP-2515	4"	482	98	4.1
SP-2521	4"	608	98	5.3
SP-2526	4"	713	98	6.2
SP-2539	4"	994	98	11.1
	6"	1068	138	13.5
▶ SP-2552	6"	1852	140	32.5

C = Maximum diameter of pump inclusive of cable guard and motor.
SP-2552 are mounted in sleeve for R 1 1/2 connection.

▶ With Sleeve .

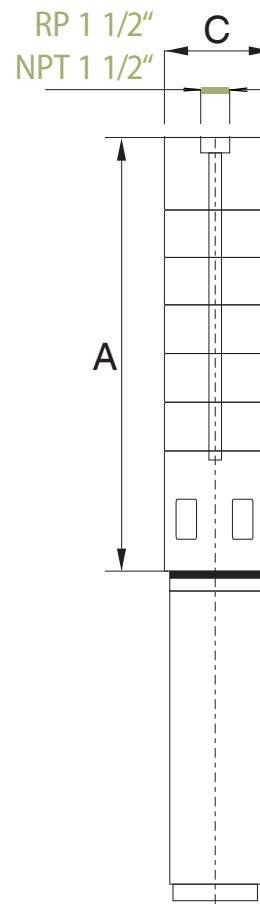

SP Series

SP 4"

SP40 Performance Curves

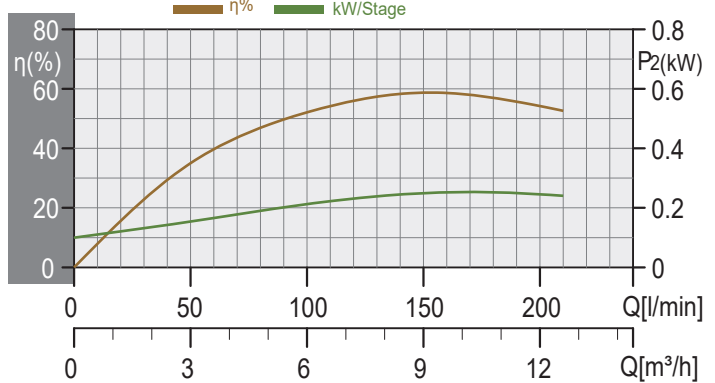
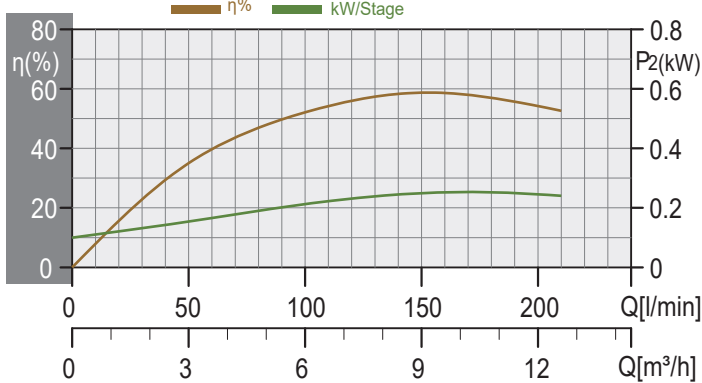
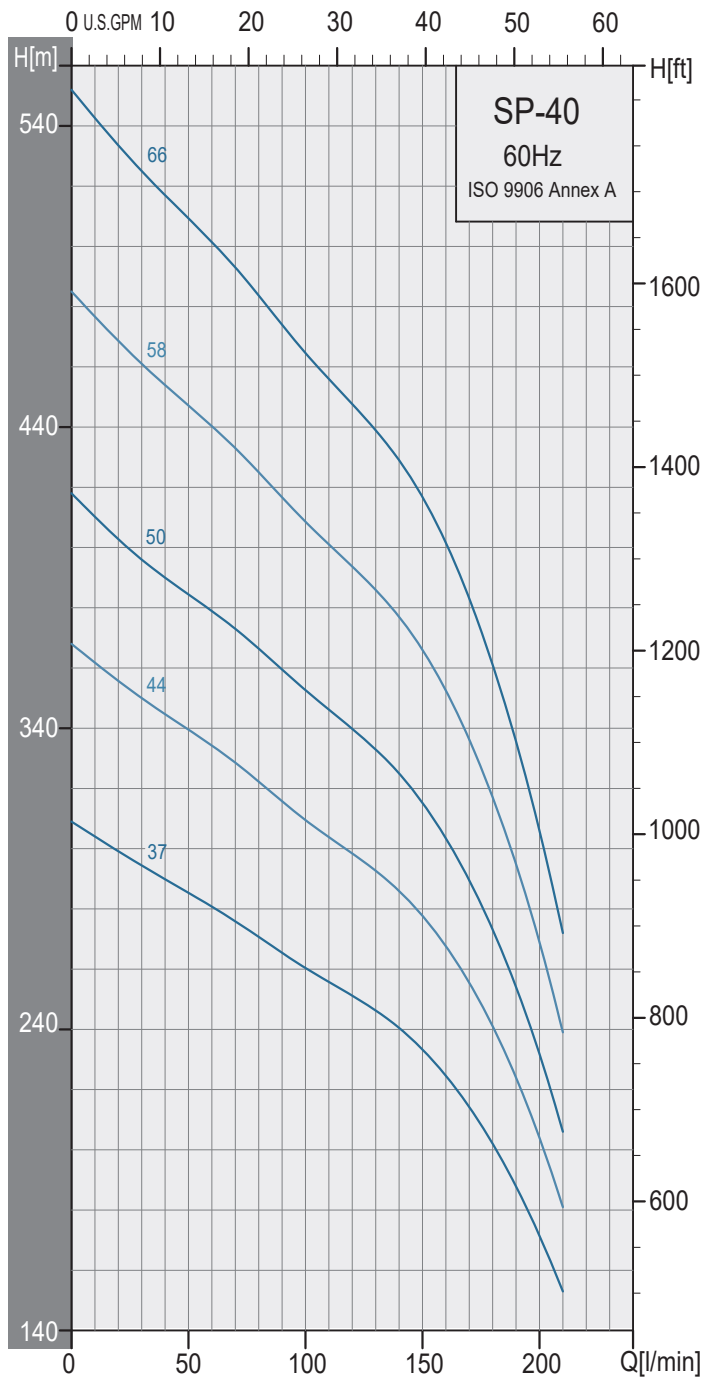
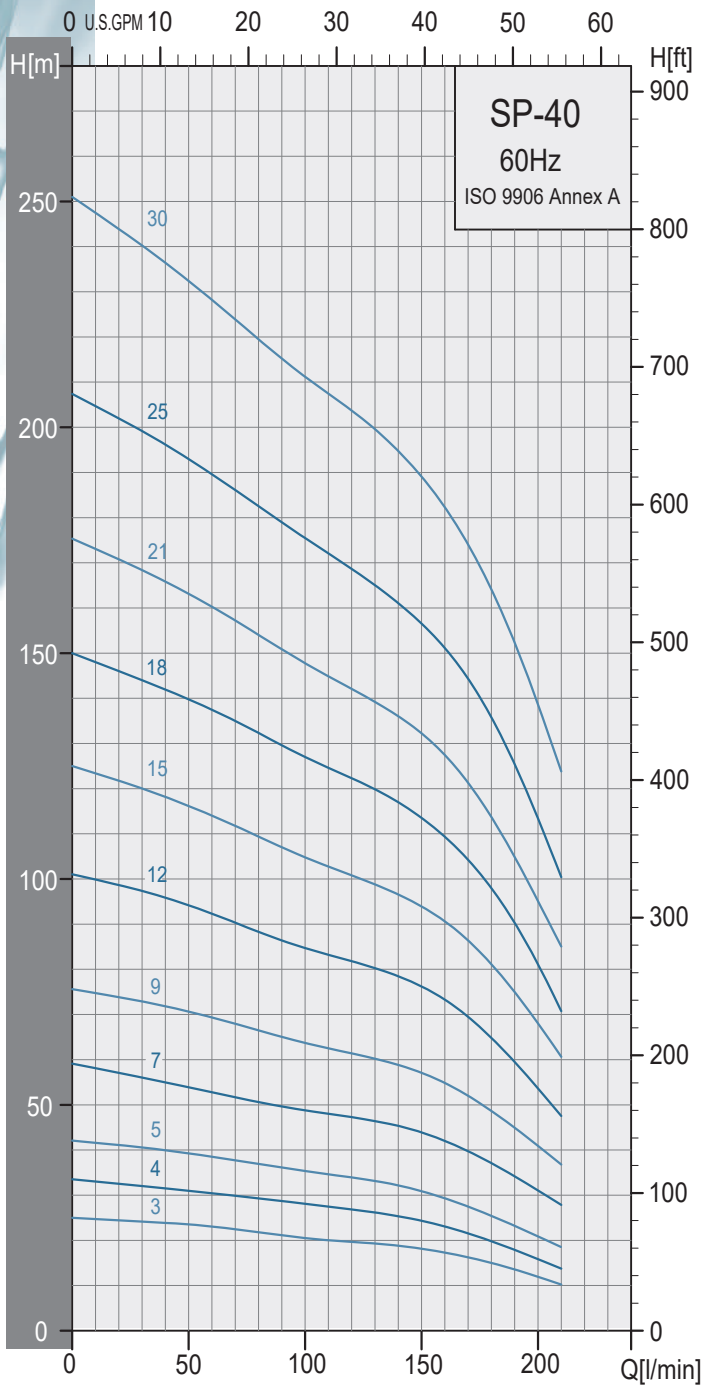

Selection Chart

60Hz

Pump Type	Motor		Q capacity 3450 rpm									
	P2		l/min m³/h	0	80	90	100	120	140	160	180	200
	KW	HP		0	4.8	5.4	6.0	7.2	8.4	9.6	10.8	12
SP-4003	0.55	0.75	HEAD IN METERS	25	22	21	20	19.5	19	17	15	12
SP-4004	0.75	1		33	29	28	27	26	25	23	20	16
SP-4005	1.1	1.5		42	37	36	35	34	32	29	25	21
SP-4007	1.5	2		59	51	50	49	47	45	42	37	31
SP-4009	2.2	3		76	66	65	64	61	59	55	49	41
SP-4012	3	4		101	88	86	85	82	78	73	65	54
SP-4015	3.7	5		125	109	107	105	101	97	91	81	68
SP-4018	5.5	7.5		150	132	129	127	122	117	109	98	81
SP-4021	5.5	7.5		175	154	151	148	142	136	127	114	95
SP-4025	5.5	7.5		207	183	179	175	169	161	151	136	113
SP-4030	7.5	10		251	220	215	211	204	195	182	164	139
SP-4037	11	15		309	270	265	260	251	241	224	202	172
SP-4044	11	15		368	322	315	309	298	286	268	241	204
▶ SP-4050	13	17.5		418	366	359	352	339	325	304	273	232
▶ SP-4058	15	20		485	425	416	408	393	377	353	317	269
▶ SP-4066	15	20		552	484	474	465	448	429	402	361	306

*Higher pressure , longer stages pumps up to 66 stages are available on request.

▶ With Sleeve .

Dimensions and weights

Pump Type	Motor Dia.	Dimensions (mm)		Net Weight (Kg) Pump
		A	C	
SP-4003	4"	328	98	3.3
SP-4004	4"	370	98	3.8
SP-4005	4"	412	98	4.3
SP-4007	4"	496	98	5.3
SP-4009	4"	580	98	6.3
SP-4012	4"	706	98	7.3
SP-4015	4"	832	98	9.3
SP-4018	4"	958	98	10.8
SP-4021	6"	1024	138	12.6
	4"	1084	98	12.3
SP-4025	6"	1150	138	14.1
	4"	1252	98	14.3
SP-4030	6"	1318	138	16.1
	4"	1459	98	16.8
SP-4037	6"	1525	138	18.7
	6"	1819	138	22.0
SP-4044	6"	2116	138	25.6
▶ SP-4050	6"	2669	140	51.6
▶ SP-4058	6"	3005	140	58.0
▶ SP-4066	6"	3341	140	64.6

C = Maximum diameter of pump inclusive of cable guard and motor.
 SP-4050 to SP-4066 are mounted in sleeve for R 2 connection.

▶ With Sleeve .

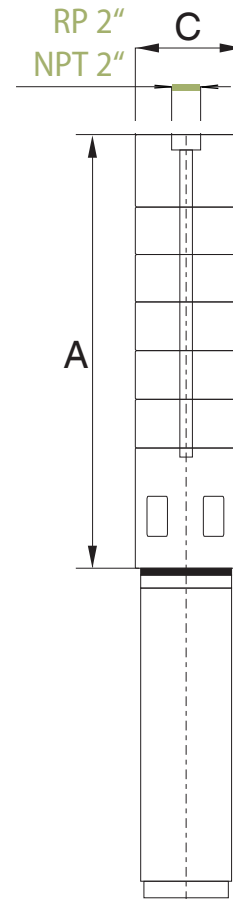

SP Series

SP 4"

SP70 Performance Curves

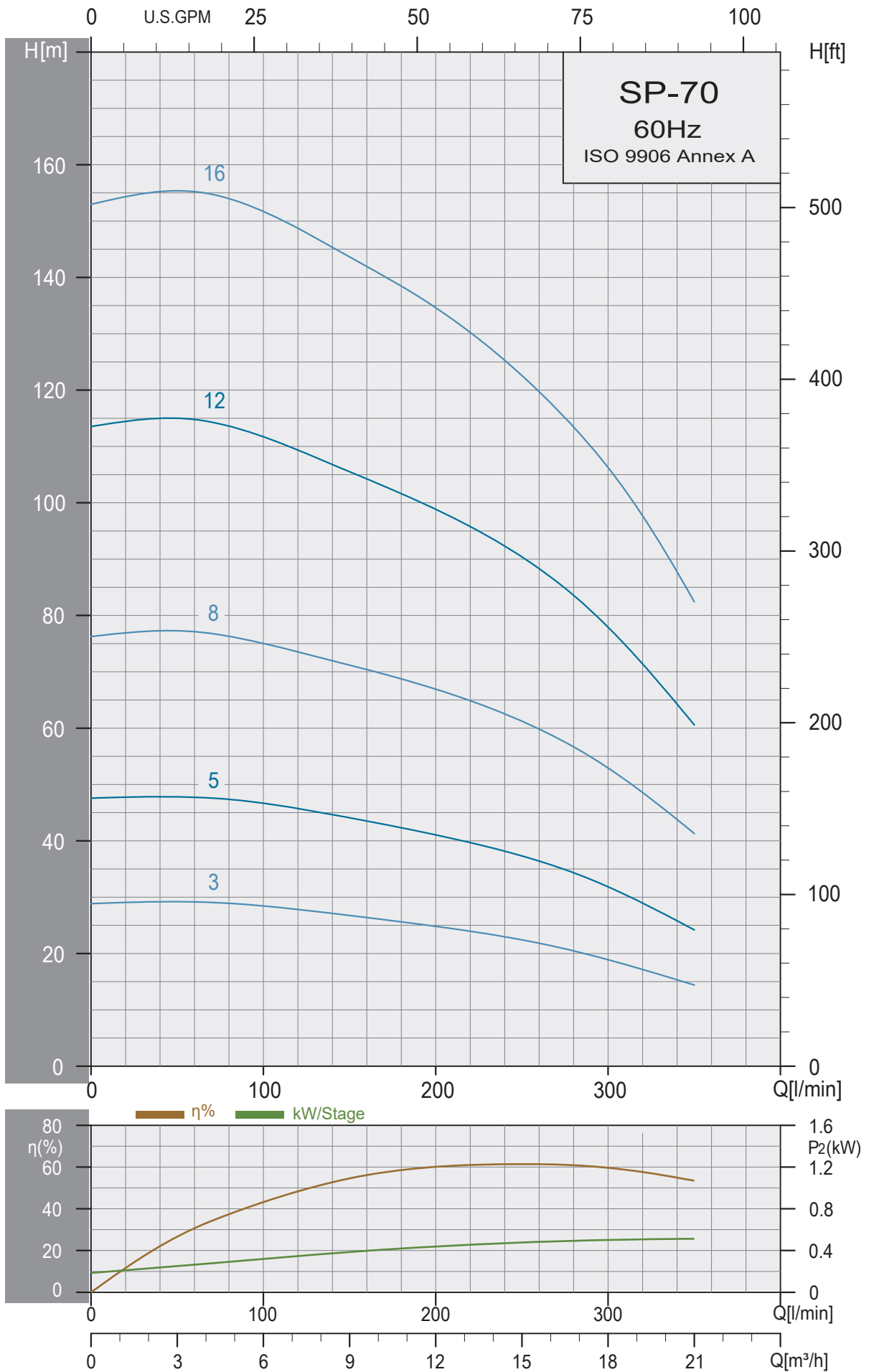

Selection Chart

60Hz

Pump Type	Motor		Q capacity 3450 rpm								
	P2		l/min m³/h	0	140	160	180	200	250	300	350
	KW	HP		0	8.4	9.6	10.8	12	15	18	21
SP-7003	1.5	2	HEAD IN METERS	29	28	27	26	25	22	19	14
SP-7005	2.2	3		48	45	44	42	41	37	32	24
SP-7008	3.7	5		76	72	70	69	67	61	53	41
SP-7012	5.5	7.5		114	107	104	102	99	90	78	61
SP-7016	7.5	10		153	145	142	138	135	123	106	82

Dimensions and weights

Pump Type	Motor Dia.	Dimensions (mm)		Net Weight (Kg) Pump
		A	C	
SP-7003	4"	375	98	3.7
SP-7005	4"	505	98	5.0
SP-7008	4"	700	98	7.0
SP-7012	4"	960	98	9.5
	6"	1025	136	11.8
SP-7016	4"	1220	98	12.1
	6"	1285	136	14.5

C=Maximum diameter of pump inclusive of cable guard and motor.

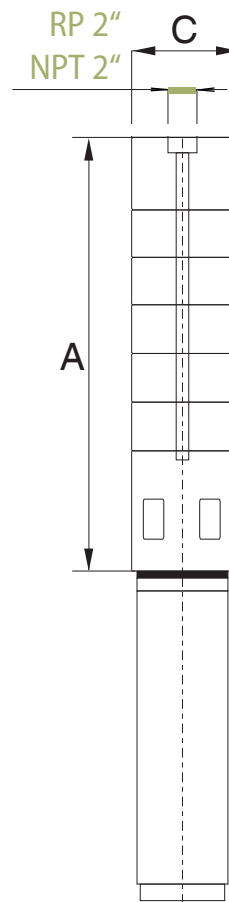

SP Series

SP 6"

SP90 Performance Curves

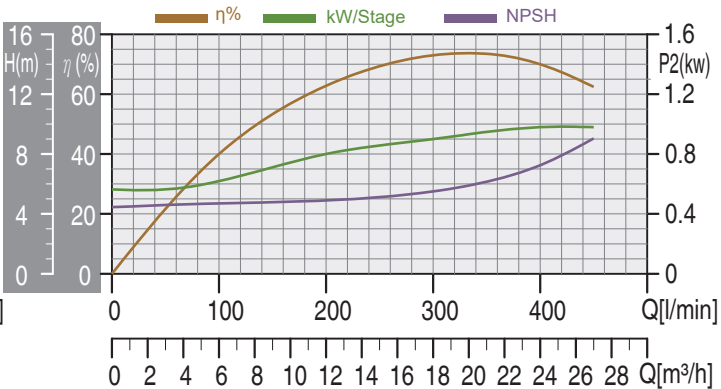
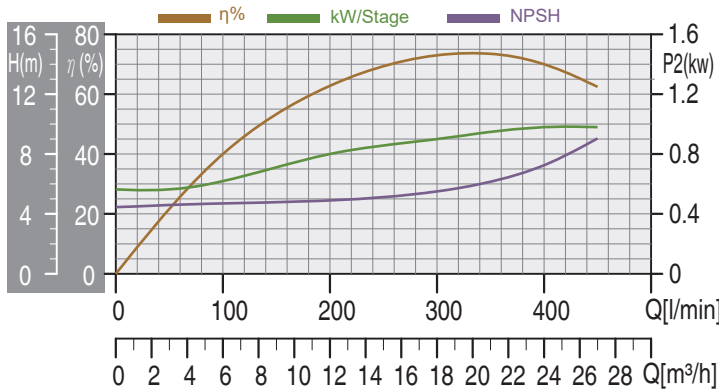
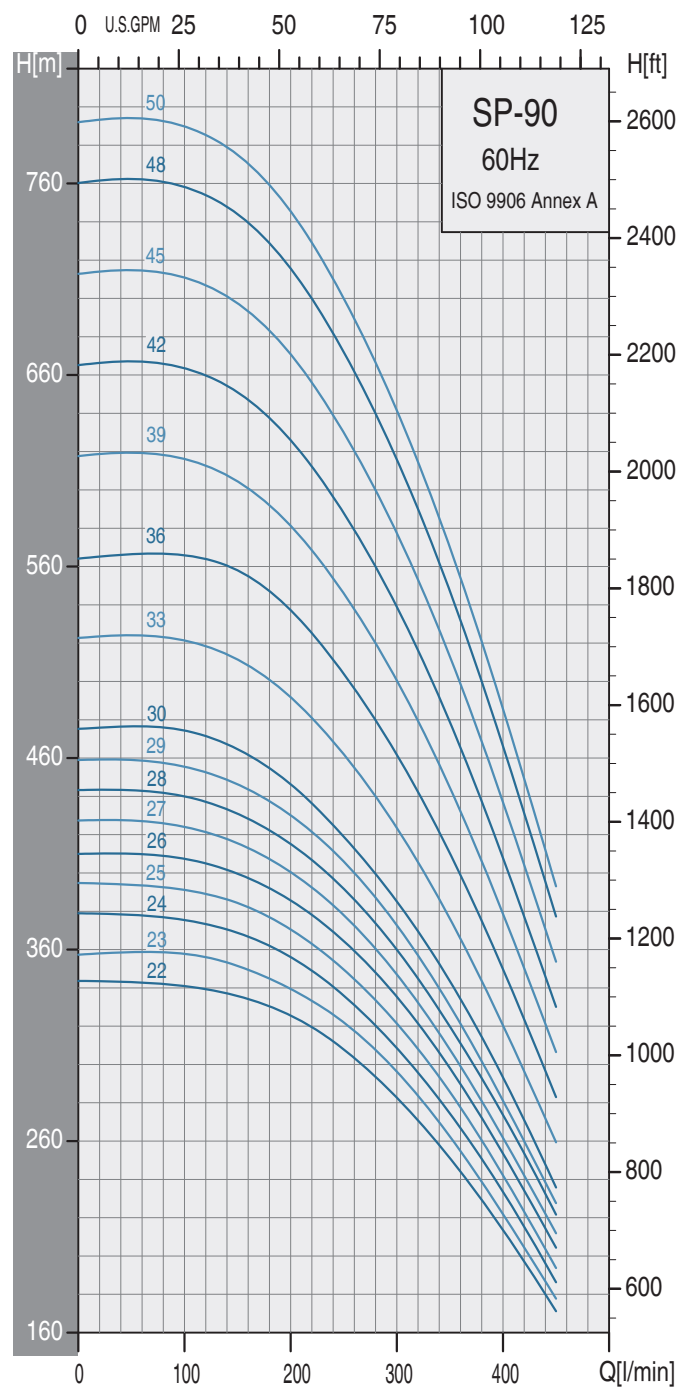
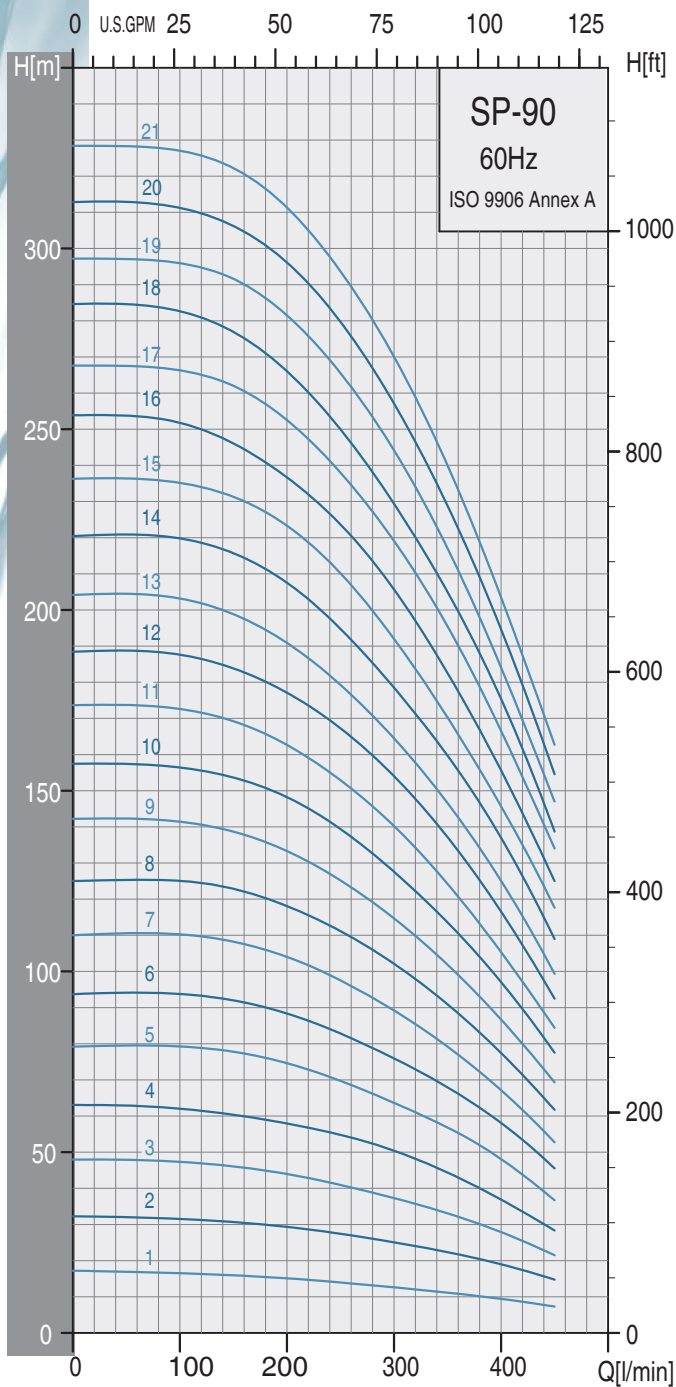

Selection Chart

60Hz

Dimensions and weights

Pump Type	Motor		m³/h l/min	Q capacity 3450 rpm							
	P2			6	9	12	15	18	21	24	27
	KW	HP		100	150	200	250	300	350	400	450
SP 90-1	1.1	1.5	17	15	14	13	13	13	9	8	
SP 90-2	2.2	3	32	31	29	28	25	23	19	16	
SP 90-3	3	4	48	47	44	41	38	33	28	22	
SP 90-4	3.7	5	62	60	58	55	50	45	37	28	
SP 90-5	5.5	7.5	79	78	75	70	63	57	48	37	
SP 90-6	5.5	7.5	93	92	88	83	76	68	58	46	
SP 90-7	7.5	10	110	108	103	98	89	79	68	53	
SP 90-8	7.5	10	125	122	118	112	102	91	78	62	
SP 90-9	7.5	10	141	138	133	125	115	102	88	70	
SP 90-10	9.3	12.5	157	154	148	140	128	115	98	78	
SP 90-11	9.3	12.5	172	169	162	153	140	125	106	84	
SP 90-12	11	15	188	184	177	167	154	138	117	93	
SP 90-13	11	15	203	199	190	179	165	147	125	100	
SP 90-14	13	17.5	220	216	208	195	179	160	138	110	
SP 90-15	13	17.5	235	231	223	210	192	170	146	119	
SP 90-16	15	20	252	247	237	224	206	184	156	126	
SP 90-17	15	20	268	262	252	238	219	196	166	134	
SP 90-18	15	20	283	277	266	250	230	205	176	140	
SP 90-19	18.5	25	295	292	282	266	245	218	185	147	
SP 90-20	18.5	25	311	307	297	280	258	229	195	155	
SP 90-21	18.5	25	327	322	312	294	271	241	205	163	
SP 90-22	18.5	25	341	336	325	308	282	251	214	170	
SP 90-23	22	30	357	351	340	322	295	262	223	178	
SP 90-24	22	30	376	369	357	336	309	275	233	186	
SP 90-25	22	30	392	384	372	350	322	287	243	194	
SP 90-26	22	30	408	400	386	365	336	298	253	205	
SP 90-27	26	35	424	416	400	378	347	308	263	212	
SP 90-28	26	35	440	431	415	392	360	320	273	220	
SP 90-29	26	35	456	446	430	406	373	331	283	228	
SP 90-30	26	35	473	465	446	420	385	343	293	236	
▶ SP 90-33	30	40	521	512	492	462	424	376	321	259	
▶ SP 90-36	30	40	566	558	537	504	462	410	350	283	
▶ SP 90-39	37	50	616	605	581	546	500	445	379	307	
▶ SP 90-42	37	50	663	651	626	588	539	479	408	330	
▶ SP 90-45	45	60	711	698	671	630	577	513	437	354	
▶ SP 90-48	45	60	758	744	716	672	616	574	466	377	
▶ SP 90-50	45	60	790	775	746	700	641	570	486	393	

HEAD IN METERS

Pump Type	Motor Dia.	Dimensions (mm)			Net Weight (Kg) Pump
		A	C*	C**	
		SP 90-1	4"	343	
SP 90-2	4"	403	131		6.4
SP 90-3	4"	464	131		7.9
SP 90-4	4"	524	131		9.3
SP 90-5	4"	566	131		9.9
	6"	585	142	142	10.8
SP 90-6	4"	626	131		11.3
	6"	645	142	142	12.2
SP 90-7	4"	687	131		12.6
	6"	706	142	142	13.7
SP 90-8	4"	747	131		13.9
	6"	766	142	142	15.1
SP 90-9	4"	808	131		15.2
	6"	827	142	142	16.6
SP 90-10	6"	887	142	142	18.0
SP 90-11	6"	948	142	142	19.5
SP 90-12	6"	1008	142	142	20.9
SP 90-13	6"	1069	142	142	22.4
SP 90-14	6"	1129	142	142	23.8
SP 90-15	6"	1190	142	142	25.3
SP 90-16	6"	1250	142	142	26.7
SP 90-17	6"	1311	142	142	28.2
SP 90-18	6"	1371	142	142	29.6
SP 90-19	6"	1432	142	142	31.1
SP 90-20	6"	1492	142	142	32.5
SP 90-21	6"	1553	142	142	34.0
SP 90-22	6"	1613	142	142	35.4
SP 90-23	6"	1674	142	142	36.9
SP 90-24	6"	1734	142	142	38.3
SP 90-25	6"	1795	142	142	39.8
SP 90-26	6"	1855	142	142	41.2
SP 90-27	6"	1916	142	142	42.7
SP 90-28	6"	1976	142	142	44.1
SP 90-29	6"	2037	142	142	45.6
SP 90-30	6"	2097	142	142	47.0
▶ SP 90-33	6"	2650	178	181	100.1
▶ SP 90-36	6"	2832	178	181	106.6
▶ SP 90-39	6"	3013	178	181	113.1
▶ SP 90-42	8"	3148	192	192	122.0
▶ SP 90-45	8"	3329	192	192	128.1
▶ SP 90-48	8"	3511	192	192	134.6
▶ SP 90-50	8"	3632	192	192	138.0

*Higher pressure , longer stages pumps up to 50 stages are available on request.

▶ With Sleeve .

C*: Maximum diameter of pump with one motor cable

C**: Maximum diameter of pump with two motor cable

SP-9033 to SP-9050 are mounted in sleeve for R 3 connection.

▶ With Sleeve .

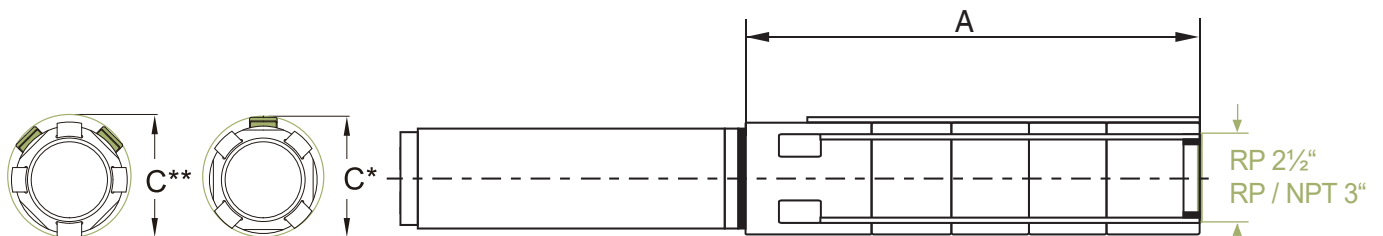

SP Series

SP 6"

SP150 Performance Curves

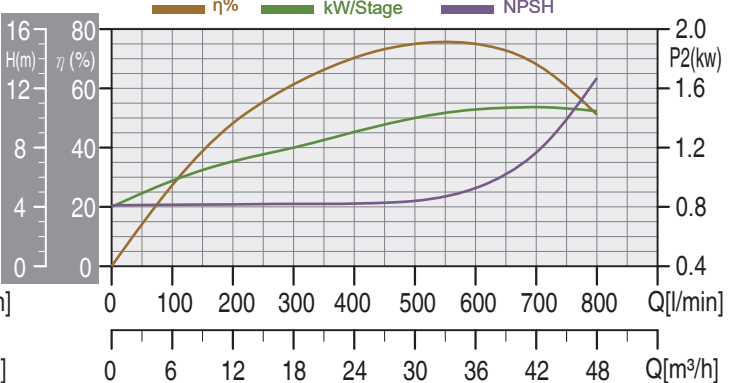
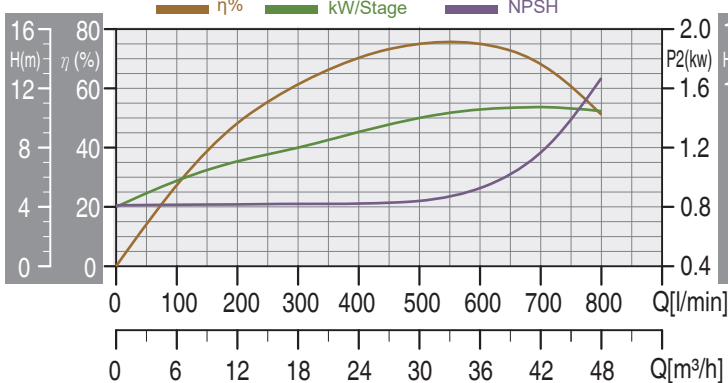
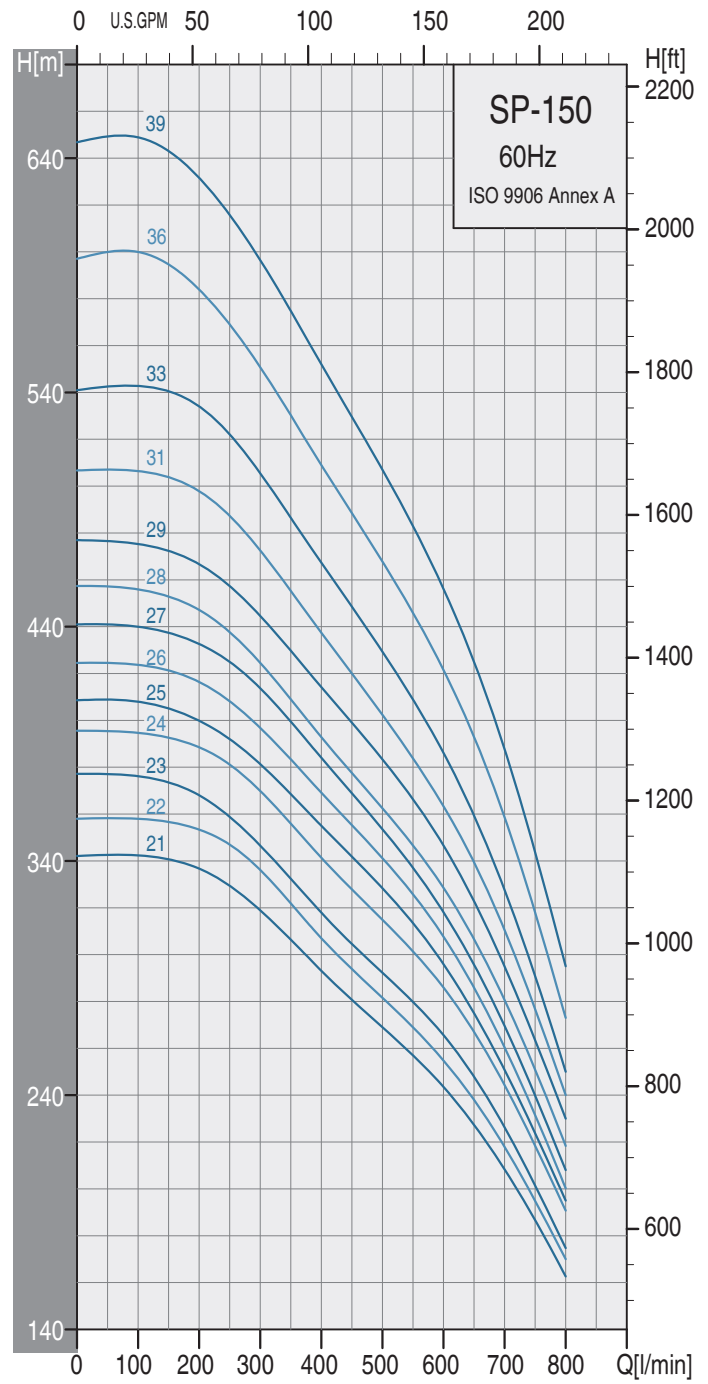
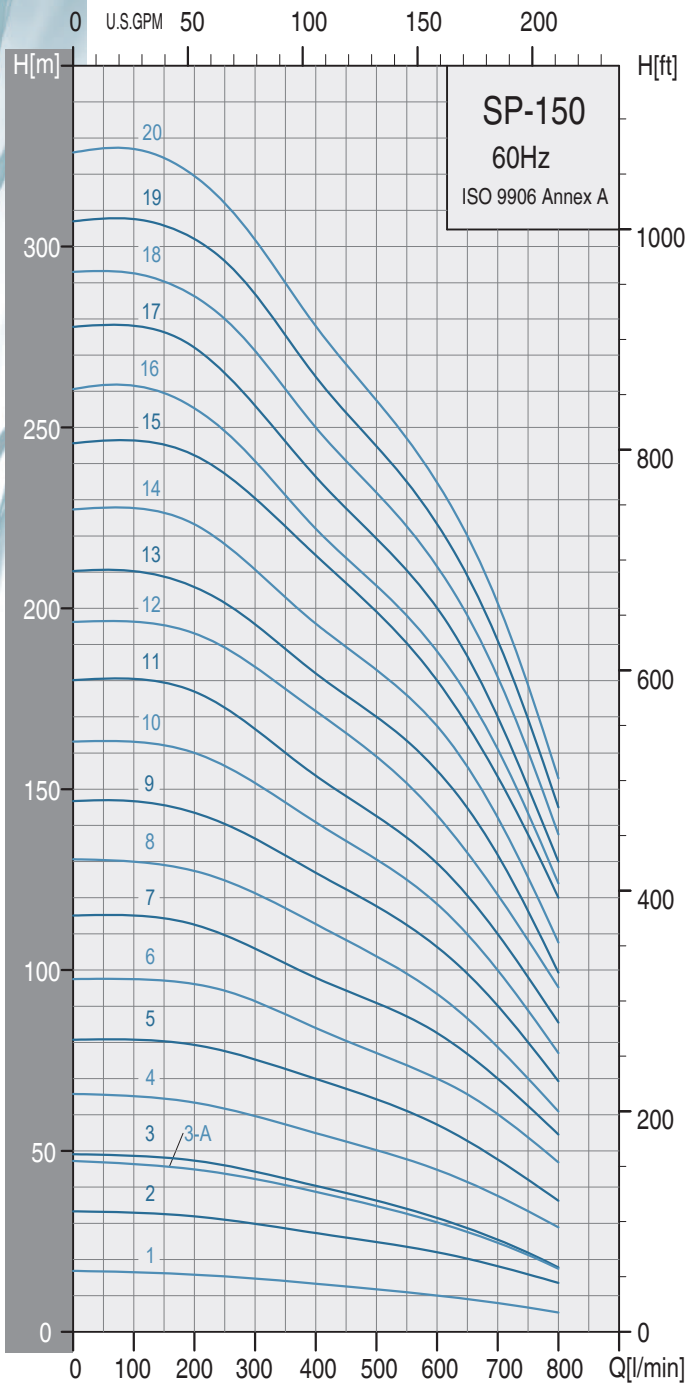

Selection Chart

60Hz Dimensions and weights

Pump Type	Motor		Q capacity 3450 rpm														
	P2 KW	HP	m³/h l/min	HEAD IN METERS													
				12	15	18	21	24	27	30	33	36	39	42	45	48	
SP 150-1	1.5	2	16	15.5	15	14	13.5	13	12	11	10	9	8	6	5		
SP 150-2	3	4	32	31	29	28	27	26	24	23	22	20	18	16	13		
SP 150-3A	3.7	5	44	43	42	40	38	36	34	32	30	27	24	21	17		
SP 150-3	4	5.5	47	46	45	42	40	38	36	34	32	29	26	22	18		
SP 150-4	5.5	7.5	63	62	59	57	55	53	50	47	45	41	37	34	28		
SP 150-5	7.5	10	79	77	75	72	70	67	64	61	58	53	47	42	36		
SP 150-6	9.3	12.5	97	94	91	87	84	81	78	75	70	66	60	54	47		
SP 150-7	9.3	12.5	113	110	106	102	98	94	91	87	82	77	70	63	55		
SP 150-8	11	15	128	125	121	117	113	108	104	99	93	87	78	70	61		
SP 150-9	13	17.5	144	140	137	131	127	122	117	113	106	99	90	79	69		
SP 150-10	13	17.5	160	156	152	146	141	136	130	125	118	110	100	88	77		
SP 150-11	15	20	177	172	167	160	154	148	143	137	129	120	110	97	86		
SP 150-12	18.5	25	193	189	184	178	172	166	158	152	143	133	120	108	95		
SP 150-13	18.5	25	207	202	195	189	182	176	170	163	155	145	131	117	99		
SP 150-14	18.5	25	223	217	210	204	196	189	183	176	167	156	142	126	107		
SP 150-15	22	30	242	237	230	223	215	207	198	190	180	167	154	137	120		
SP 150-16	22	30	255	249	241	231	222	214	206	198	188	176	161	143	124		
SP 150-17	22	30	272	265	256	246	236	227	219	210	200	187	170	150	130		
SP 150-18	26	35	286	280	271	260	250	241	232	223	212	198	181	160	138		
SP 150-19	26	35	302	296	287	275	264	254	245	235	223	209	191	169	145		
SP 150-20	26	35	312	302	290	278	267	257	247	242	235	220	201	178	153		
SP 150-21	30	40	337	329	318	306	293	280	269	257	244	227	208	186	162		
SP 150-22	30	40	353	347	336	322	307	294	282	269	255	238	218	195	170		
SP 150-23	30	40	367	358	346	333	318	305	292	280	266	248	226	201	175		
SP 150-24	37	50	388	381	370	356	342	328	315	302	286	267	244	218	190		
SP 150-25	37	50	400	392	381	369	355	342	328	314	296	275	251	224	195		
SP 150-26	37	50	416	408	396	383	369	356	341	326	308	286	260	231	200		
SP 150-27	37	50	432	425	414	399	384	369	354	337	318	296	270	240	208		
SP 150-28	37	50	447	438	424	409	393	377	363	347	328	306	280	250	218		
▶ SP 150-29	45	60	466	457	445	429	414	399	383	367	346	322	295	263	230		
▶ SP 150-31	45	60	497	487	472	455	437	420	403	384	363	340	310	276	240		
▶ SP 150-33	45	60	535	522	505	486	467	449	429	409	386	360	327	290	250		
▶ SP 150-36	55	75	584	569	551	530	509	488	468	446	422	393	359	318	273		
▶ SP 150-39	55	75	632	616	596	575	552	530	507	483	456	425	388	344	295		

Pump Type	Motor Dia.	Dimensions (mm)			Net Weight (Kg) Pump
		A	C*	C**	
SP 150-1	4"	366	131		6.7
SP 150-2	4"	462	131		8.4
SP 150-3A	4"	558	131		10.1
SP 150-3	4"	558	131		10.1
SP 150-4	4"	635	131		11.0
	6"	654	142	142	11.8
SP 150-5	4"	731	131		12.8
	6"	750	142	142	13.5
SP 150-6	6"	846	142	142	15.2
SP 150-7	6"	942	142	142	16.9
SP 150-8	6"	1038	142	142	18.6
SP 150-9	6"	1134	142	142	20.3
SP 150-10	6"	1230	142	142	22.0
SP 150-11	6"	1326	142	142	23.6
SP 150-12	6"	1422	142	142	25.3
SP 150-13	6"	1518	142	142	27.0
SP 150-14	6"	1614	142	142	28.7
SP 150-15	6"	1710	142	142	30.4
SP 150-16	6"	1806	142	142	32.1
SP 150-17	6"	1902	142	142	33.8
SP 150-18	6"	1998	142	142	35.5
SP 150-19	6"	2094	142	142	37.2
SP 150-20	6"	2190	142	142	38.9
SP 150-21	6"	2286	142	142	40.6
SP 150-22	6"	2382	142	142	42.3
SP 150-23	6"	2478	142	142	44.0
SP 150-24	6"	2574	142	142	45.6
SP 150-25	6"	2670	142	142	47.3
SP 150-26	6"	2766	142	142	49
SP 150-27	6"	2862	142	142	50.7
SP 150-28	6"	2958	142	142	52.4
▶ SP 150-29	6"	3431	177	181	112
▶ SP 150-31	6"	3623	177	181	118
▶ SP 150-33	6"	3815	177	181	124
▶ SP 150-36	8"	4056	192	192	133
▶ SP 150-39	8"	4344	192	192	142

*Higher pressure , longer stages pumps up to 39 stages are available on request.

▶ With Sleeve .

C* : Maximum diameter of pump with one moter cable.
 C** : Maximum diameter of pump with two moter cable.
 SP150-29 to SP150-39 are mounted in sleeve for R 3 connection.
 ▶ With Sleeve .

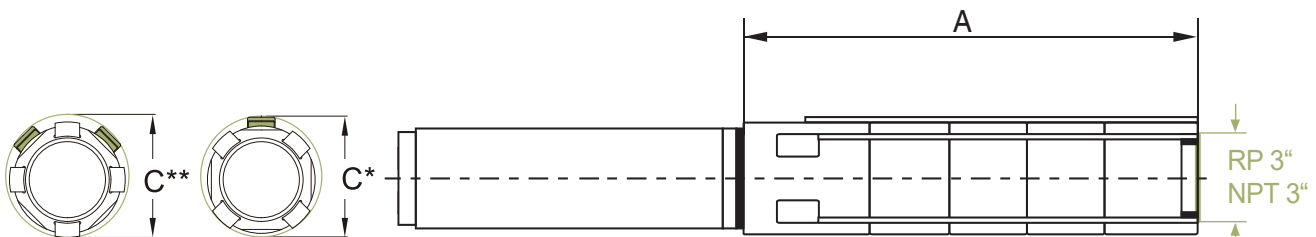

SP Series

SP 6"

SP230 Performance Curves

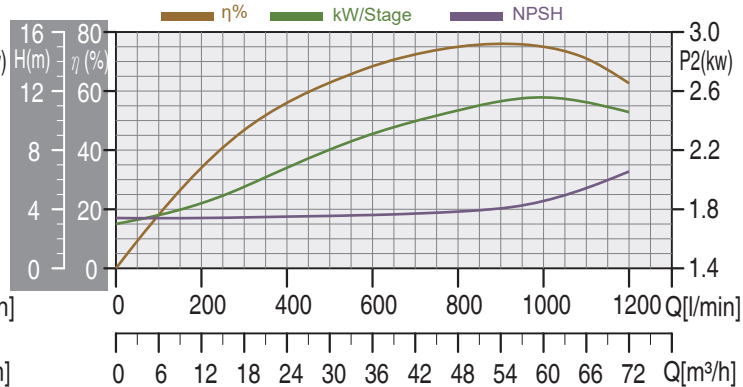
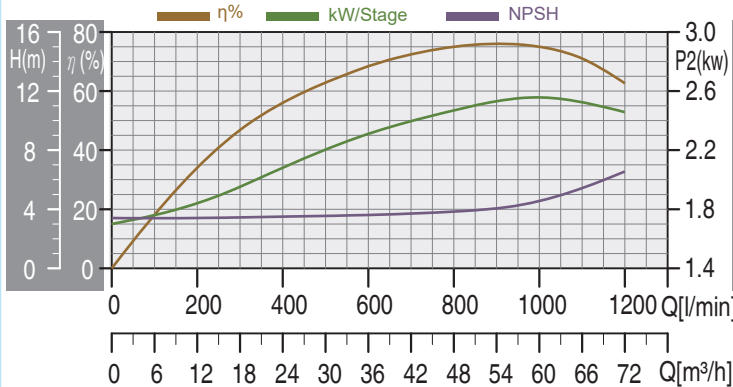
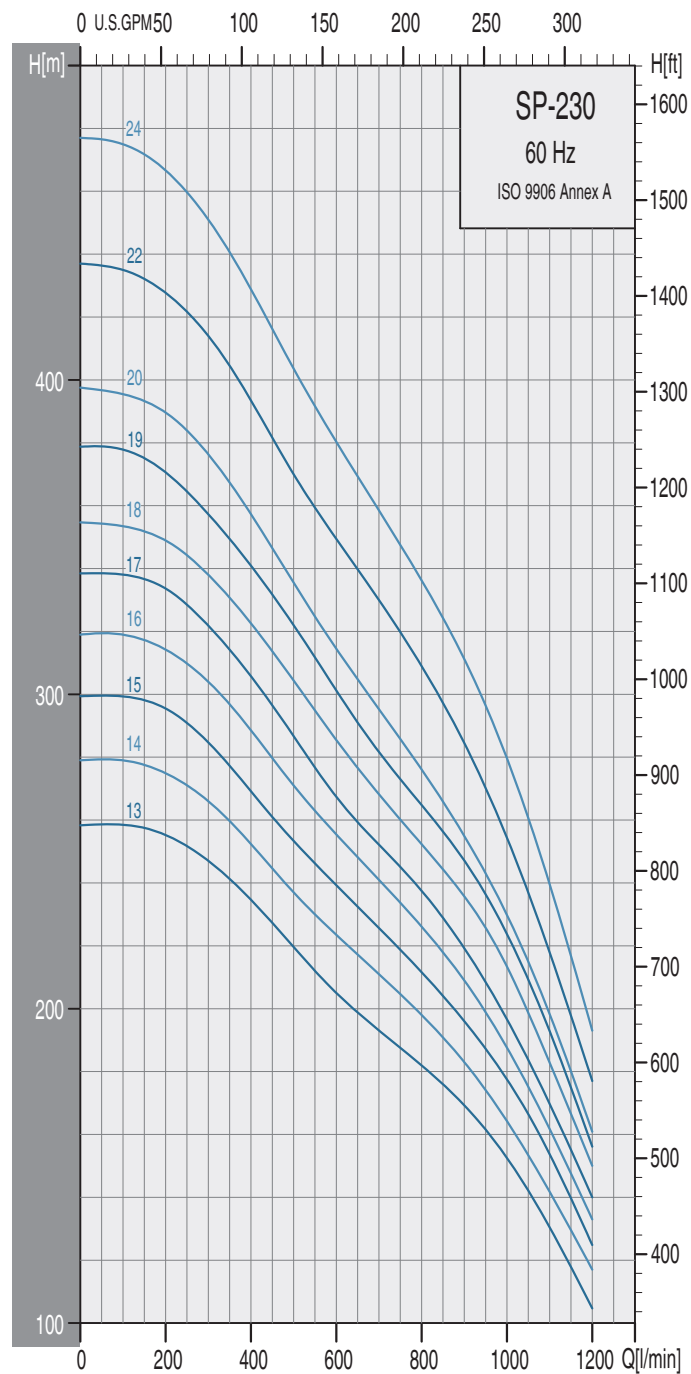
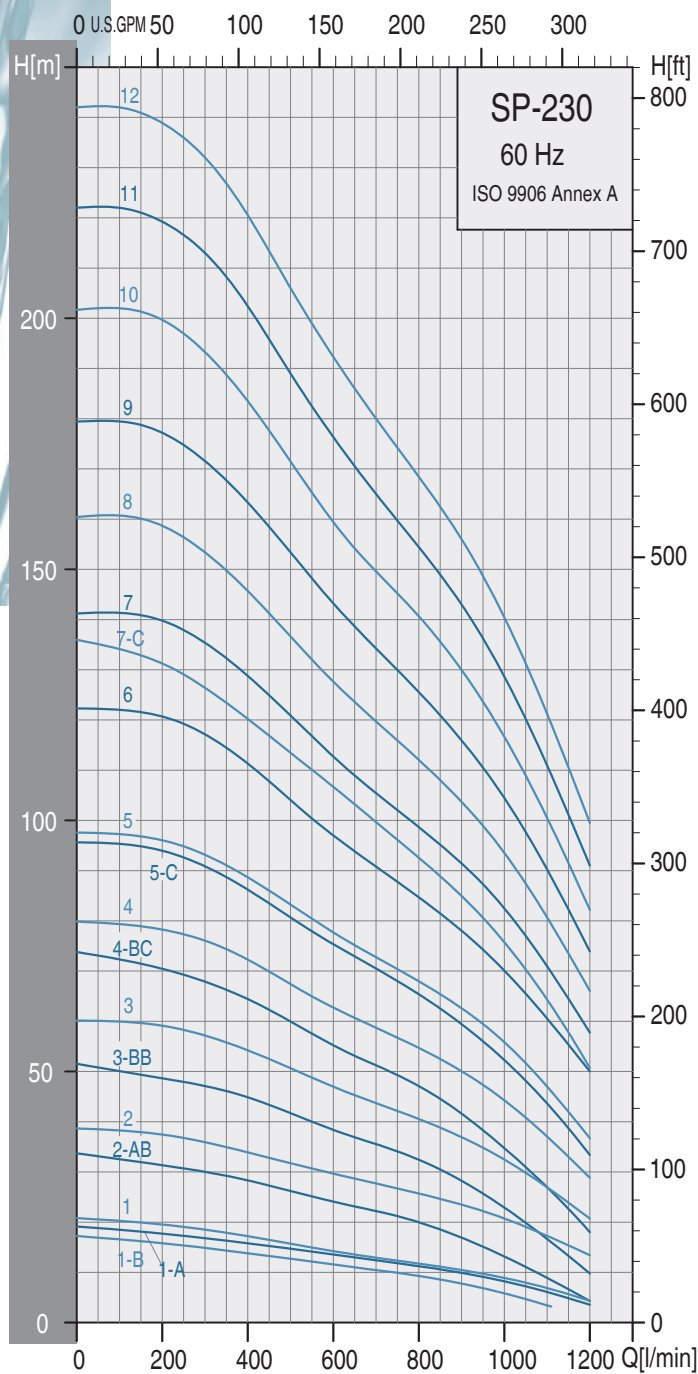

Selection Chart

Pump Type	Motor		m ³ /h l/min	Q capacity 3450 rpm													
	P2			18	21	24	27	30	33	36	42	48	54	60	66	72	
	KW	HP		300	350	400	450	500	550	600	700	800	900	1000	1100	1200	
SP 230-1-B	1.5	2	HEAD IN METERS	15	14.5	14	13	12.5	12	11	10	9	8	6	3		
SP 230-1-A	2.2	3		17	16.5	16	15.5	15	14.5	14	13	11	10	8	6	3	
SP 230-1	3	4		18	17.5	17	16.5	16	15	14	13	12	11	8	6	4	
SP 230-2-AB	3.7	5		30	29	28	27	26	25	24	22	20	17	13	8	4	
SP 230-2	5.5	7.5		36	35	34	33	32	31	29	27	26	24	21	17	13	
SP 230-3-BB	5.5	7.5		47	46	45	43	42	40	38	35	32	28	23	16	10	
SP 230-3	7.5	10		57	56	54	53	51	48	47	44	40	37	33	27	21	
SP 230-4-BC	7.5	10		68	67	64	62	60	58	55	51	47	41	35	27	18	
SP 230-4	9.3	12.5		76	74	72	70	67	65	63	58	55	50	44	37	28	
SP 230-5-C	11	15		91	88	85	83	81	78	75	70	65	59	52	43	34	
SP 230-5	13	17.5		93	91	88	86	83	81	77	73	68	63	56	47	37	
SP 230-6	15	20		117	114	112	108	104	100	97	91	85	77	70	60	50	
SP 230-7C	15	20		126	123	120	117	114	110	107	99	93	85	76	65	51	
SP 230-7	18.5	25		136	133	128	125	121	117	113	106	98	92	83	71	57	
SP 230-8	18.5	25		153	150	146	141	137	132	127	120	113	104	94	80	66	
SP 230-9	22	30		172	167	163	158	154	148	143	135	126	116	105	90	74	
SP 230-10	22	30		194	188	184	177	172	165	159	150	141	130	117	100	83	
SP 230-11	26	35		213	208	202	196	189	183	176	165	155	143	128	111	91	
SP 230-12	30	40		232	227	220	213	206	199	192	180	169	156	140	121	100	
SP 230-13	30	40		247	242	235	227	220	213	205	193	182	168	153	130	105	
SP 230-14	37	50		266	259	252	245	237	230	223	211	198	183	164	142	117	
SP 230-15	37	50		285	277	269	261	254	246	239	226	212	196	177	154	125	
SP 230-16	37	50		304	297	289	280	271	263	255	241	226	209	188	162	133	
SP 230-17	37	50		322	315	306	296	287	277	267	252	237	219	197	170	140	
SP 230-18	45	60	337	331	323	314	305	295	286	268	252	236	214	183	150		
SP 230-19	45	60	357	349	341	332	322	312	301	282	265	247	224	192	156		
SP 230-20	45	60	376	367	357	346	335	325	315	295	276	255	230	198	161		
SP 230-22	55	75	414	405	393	382	370	359	349	330	309	285	254	218	177		
SP 230-24	55	75	451	441	429	416	404	392	380	358	336	311	279	239	193		

*Higher pressure , longer stages pumps up to 24 stages are available on request.

▶ With Sleeve .

Dimensions and weights

Pump Type	Motor Dia.	Dimensions (mm)			Net Weight (Kg) Pump
		A	C*	C**	
SP 230-1-B	4"	383	146		6.9
SP 230-1-A	4"	383	146		6.9
SP 230-1	4"	383	146		6.9
SP 230-2-AB	4"	496	146		9.2
SP 230-2	4"	496	146		9.2
SP 230-3-BB	4"	609	146		11.5
SP 230-3	4"	590	146		11.5
	6"	609	149	152	12.2
SP 230-4-BC	6"	722	149	152	13.7
SP 230-4	6"	722	149	152	13.7
SP 230-5-C	6"	835	149	152	16.0
SP 230-5	6"	835	149	152	16.0
SP 230-6	6"	948	149	152	18.3
SP 230-7C	6"	1061	149	152	20.6
SP 230-7	6"	1061	149	152	20.6
SP 230-8	6"	1174	149	152	22.9
SP 230-9	6"	1287	149	152	25.1
SP 230-10	6"	1400	149	152	27.4
SP 230-11	6"	1513	149	152	29.7
SP 230-12	6"	1626	149	152	32.0
SP 230-13	6"	1739	149	152	34.3
SP 230-14	6"	1852	149	152	36.6
SP 230-15	6"	1965	149	152	38.8
SP 230-16	6"	2078	149	152	41.1
SP 230-17	6"	2191	149	152	43.4
SP 230-18	6"	2304	149	152	45.7
SP 230-19	6"	2417	149	152	48.0
SP 230-20	6"	2530	149	152	50.2
SP 230-22	8"	3085	192	192	114.2
SP 230-24	8"	3311	192	192	123.0

C* : Maximum diameter of pump with one moter cable.

C** : Maximum diameter of pump with two moter cable.

SP230-22 to SP230-24 are mounted in sleeve for R 4 connection.

▶ With Sleeve .

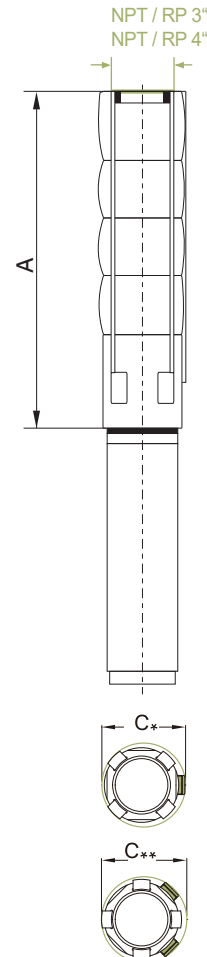

SP Series

SP 6"

SP300 Performance Curves

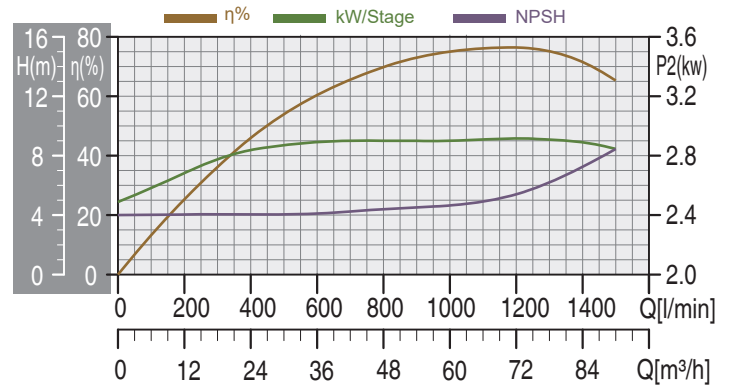
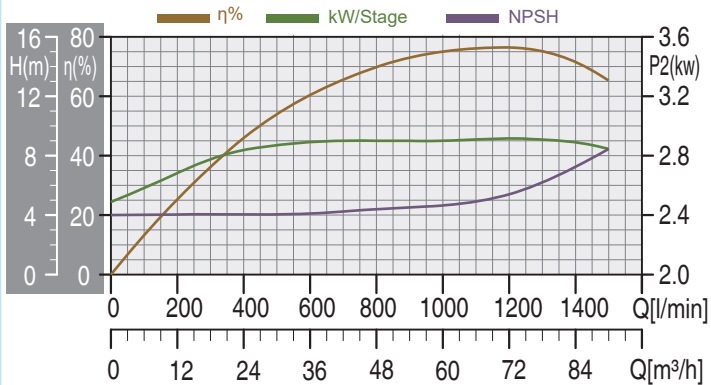
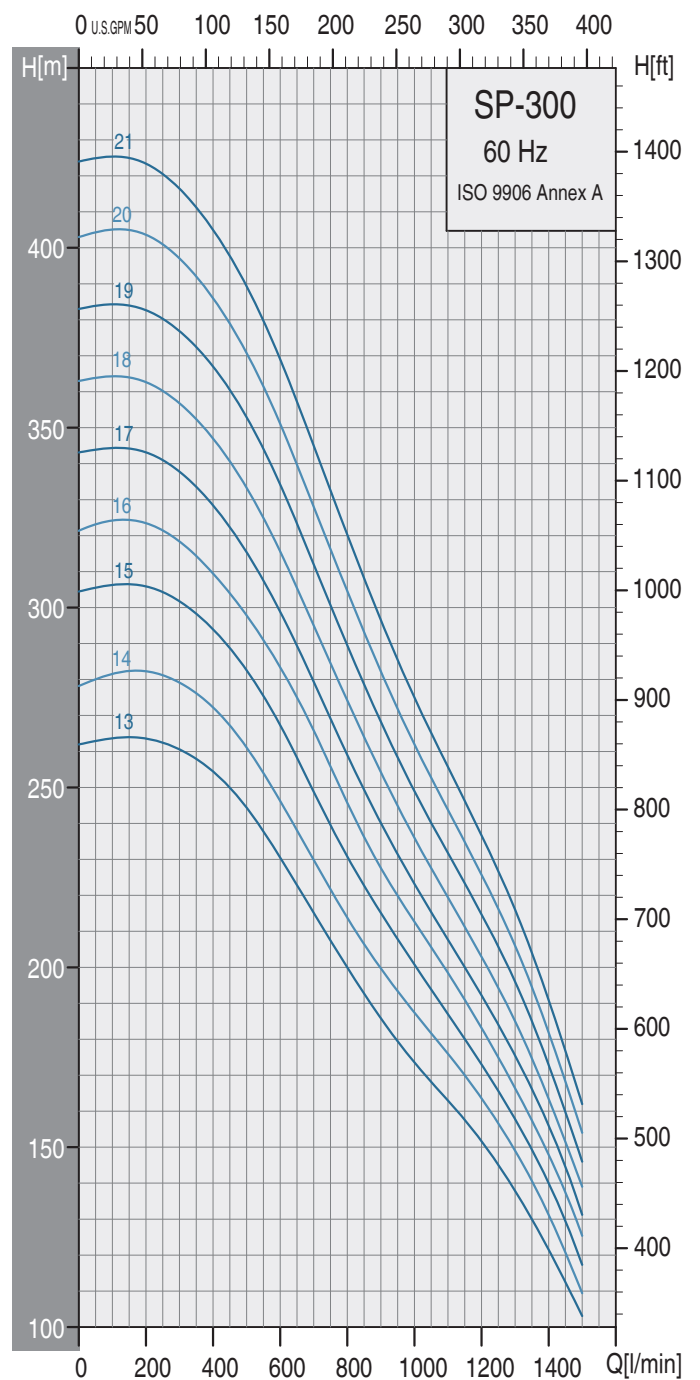
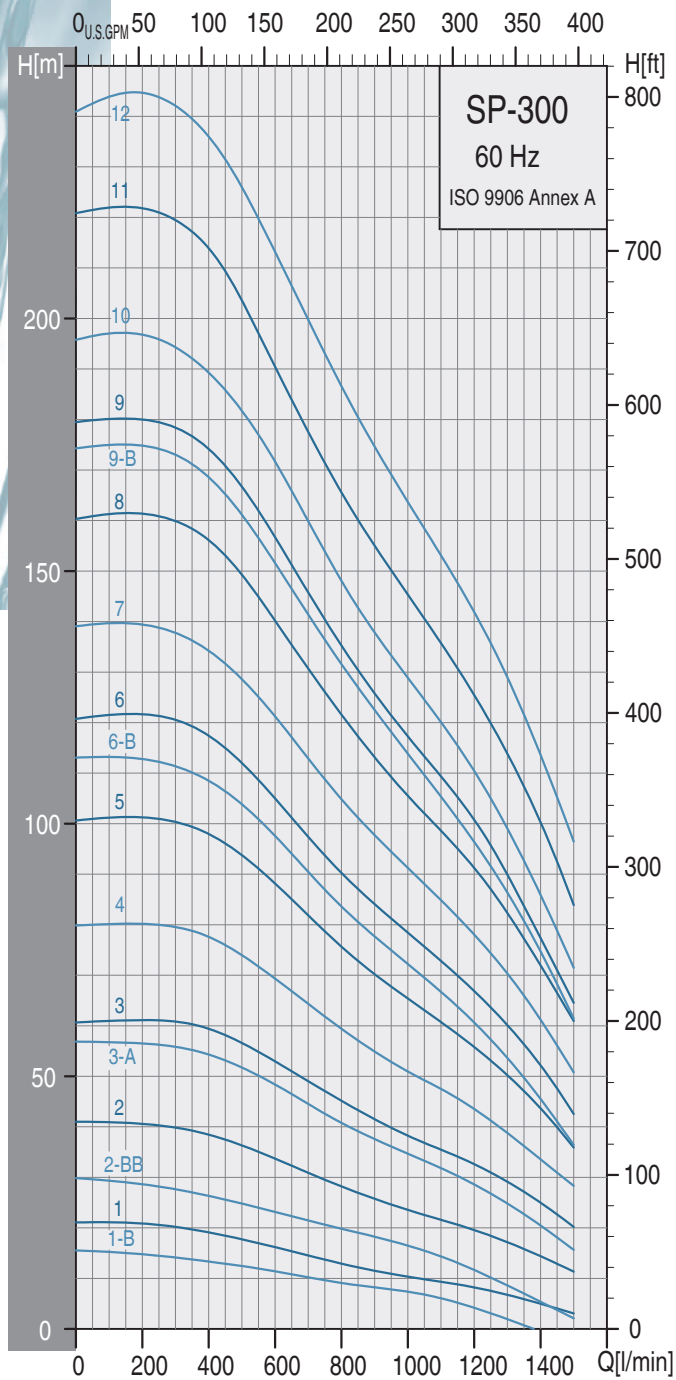

Selection Chart

60Hz

Pump Type	Motor		m ³ /h l/min	Q capacity 3450 rpm													
	P2 KW	HP		24 400	27 450	30 500	36 600	42 700	48 800	54 900	60 1000	66 1100	72 1200	78 1300	84 1400	90 1500	
SP 300-1-B	2.2	3	HEAD IN METERS	14	13	12	11	10	9	8	7	6	4	2			
SP 300-1	3.7	5		19	18	17	16	14	13	11	10	9	8	7	4	3	
SP 300-2-BB	3.7	5		26	25	24	23	22	20	18	17	14	12	8	5	2	
SP 300-2	5.5	7.5		38	37	36	34	31	28	26	24	22	19	17	15	11	
SP 300-3-A	7.5	10		54	53	52	48	44	41	38	35	32	28	25	21	16	
SP 300-3	9.3	12.5		59	58	57	53	49	46	42	38	36	33	29	25	20	
SP 300-4	11	15		77	76	74	69	65	59	55	51	47	44	39	34	28	
SP 300-5	13	17.5		98	96	94	88	82	76	70	66	61	56	50	44	36	
SP 300-6-B	15	20		108	106	104	97	90	84	77	72	66	60	54	46	37	
SP 300-6	18.5	25		117	115	112	105	97	90	84	78	73	67	60	52	43	
SP 300-7	18.5	25		134	132	129	121	113	106	98	91	85	78	70	61	51	
SP 300-8	22	30		156	153	149	140	131	122	113	106	98	91	83	72	61	
SP 300-9-B	22	30		168	165	161	152	142	132	123	114	105	96	86	75	62	
SP 300-9	26	35		174	171	167	157	146	136	126	117	109	101	90	77	65	
SP 300-10	26	35		189	186	182	172	160	148	138	129	120	110	99	86	72	
SP 300-11	30	40		214	209	204	190	177	166	155	146	136	126	114	100	84	
SP 300-12	37	50		236	232	226	213	200	187	175	164	153	142	129	114	97	
SP 300-13	37	50		255	250	245	230	215	200	186	174	163	152	138	121	104	
SP 300-14	37	50		272	267	261	246	230	214	200	187	176	163	149	131	109	
SP 300-15	45	60		294	289	283	267	249	230	215	200	187	173	158	140	118	
SP 300-16	45	60		309	304	297	283	266	246	228	212	198	183	166	148	126	
SP 300-17	45	60	328	322	316	299	279	259	240	223	208	192	175	157	131		
SP 300-18	55	75	347	341	333	315	295	274	254	236	219	203	185	163	139		
SP 300-19	55	75	367	361	353	334	312	289	268	249	232	215	196	173	146		
SP 300-20	55	75	386	378	371	351	328	305	282	262	244	226	206	182	154		
SP 300-21	63	85	405	398	389	369	345	320	297	275	256	237	216	191	162		

*Higher pressure , longer stages pumps up to 21 stages are available on request.

Dimensions and weights

Pump Type	Motor Dia.	Dimensions (mm)			Net Weight (Kg) Pump
		A	C*	C**	
SP 300-1-B	4"	383	146		6.9
SP 300-1	4"	383	146		6.9
SP 300-2-BB	4"	496	146		9.2
SP 300-2	4"	496	146		9.2
SP 300-3-A	6"	609	149	152	11.5
SP 300-3	6"	609	149	152	11.5
SP 300-4	6"	722	149	152	13.7
SP 300-5	6"	835	149	152	16.0
SP 300-6-B	6"	948	149	152	18.3
SP 300-6	6"	948	149	152	18.3
SP 300-7	6"	1061	149	152	20.6
SP 300-8	6"	1174	149	152	22.9
SP 300-9-B	6"	1287	149	152	25.1
SP 300-9	6"	1287	149	152	25.1
SP 300-10	6"	1400	149	152	27.4
SP 300-11	6"	1513	149	152	29.7
SP 300-12	6"	1626	149	152	32.0
SP 300-13	6"	1739	149	152	34.3
SP 300-14	6"	1852	149	152	36.5
SP 300-15	6"	1965	149	152	38.8
SP 300-16	6"	2078	149	152	41.1
SP 300-17	6"	2191	149	152	43.4
SP 300-18	8"	2332	183	183	51.1
SP 300-19	8"	2445	183	183	53.4
SP 300-20	8"	2558	183	183	55.7
SP 300-21	8"	2671	183	183	58

C* : Maximum diameter of pump with one moter cable.
 C** : Maximum diameter of pump with two moter cable.

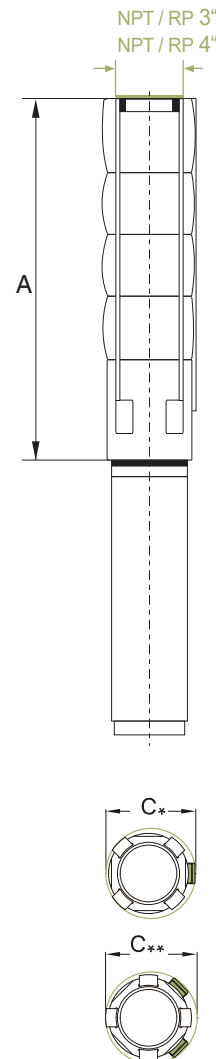

SP Series

SP 8"

SP400 Performance Curves

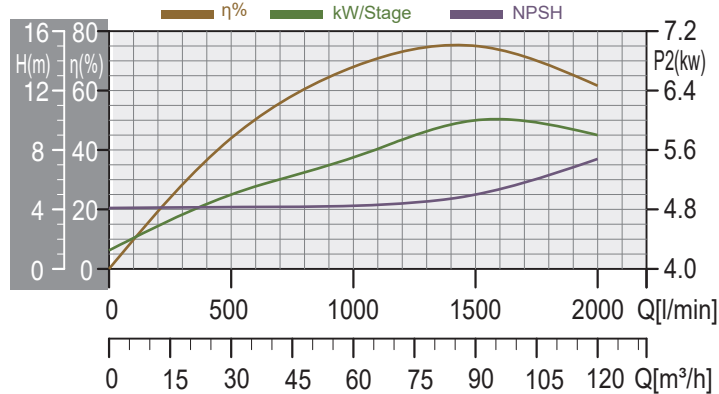
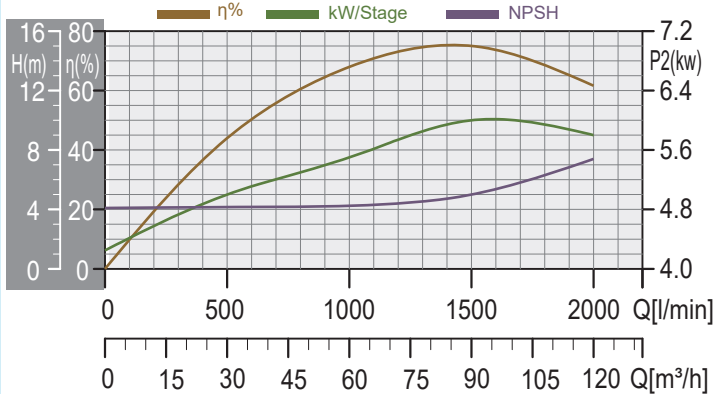
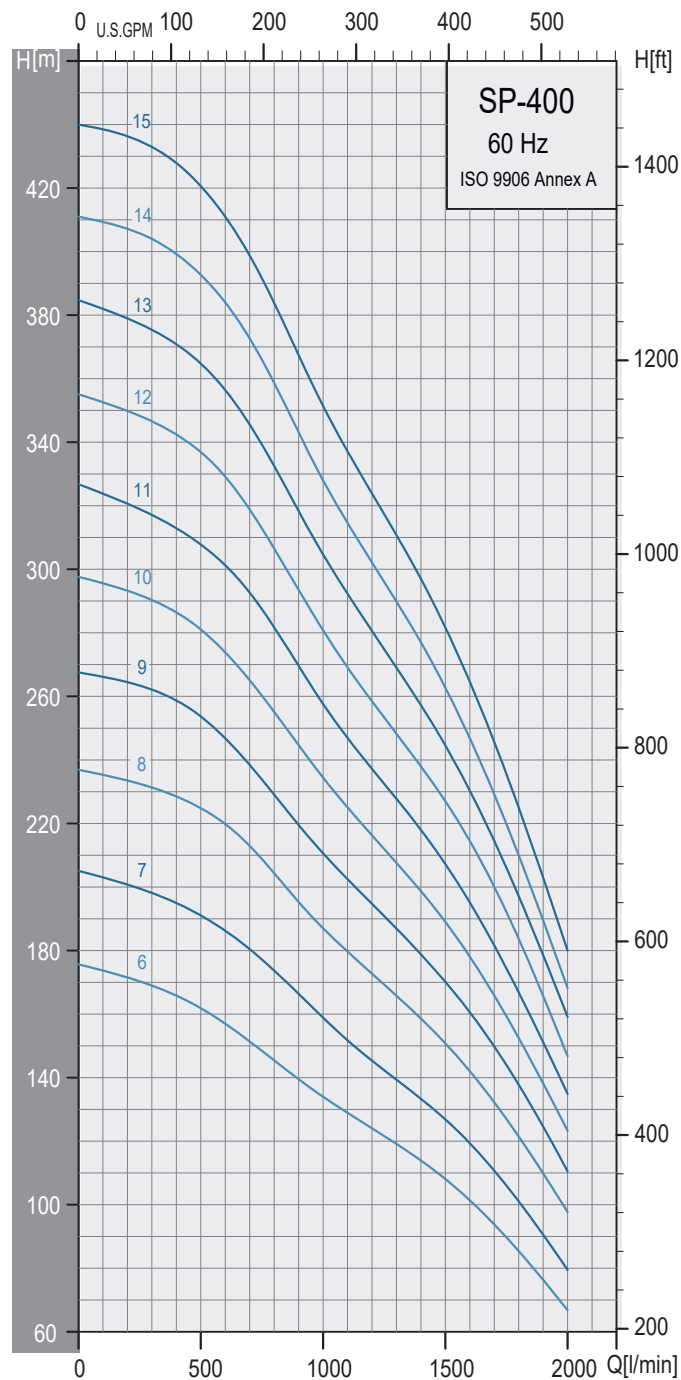
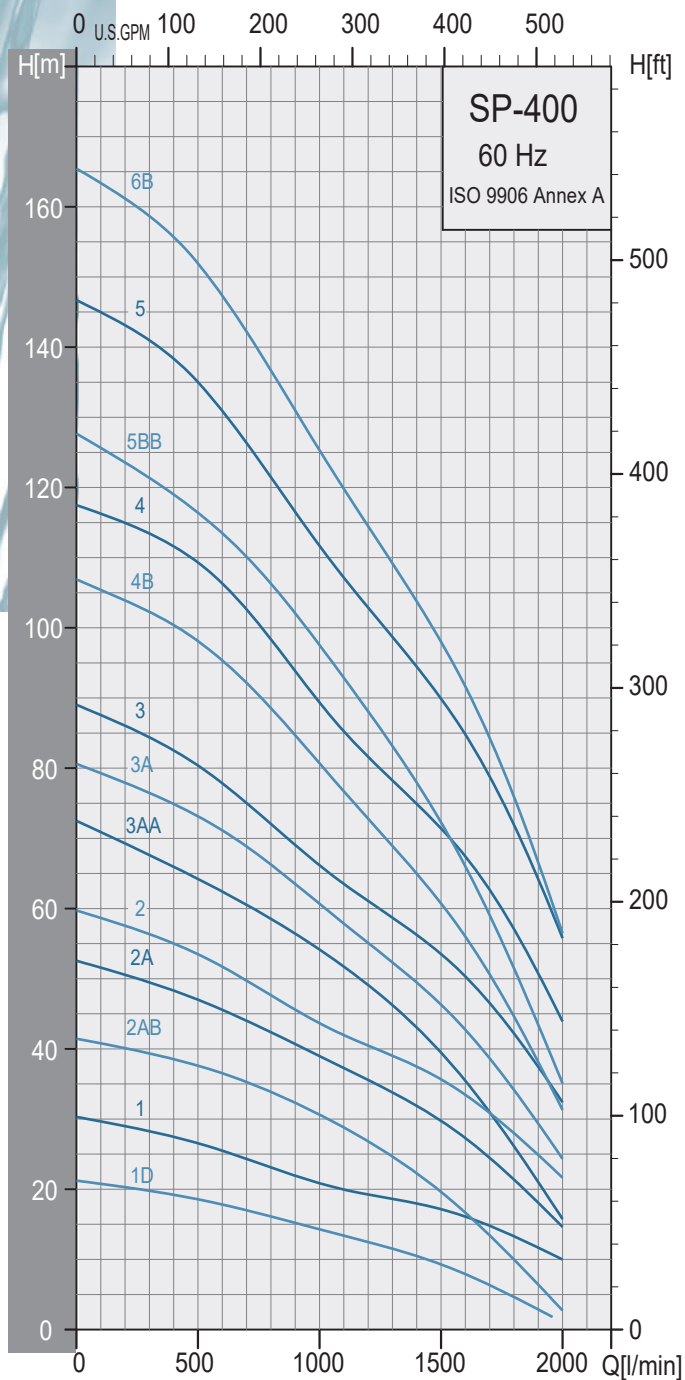

Selection Chart 60Hz

Pump Type	Motor		m³/h l/min	Q capacity 3450 rpm											
	P2			18	24	30	36	42	48	60	72	84	96	108	120
	KW	HP		300	400	500	600	700	800	1000	1200	1400	1600	1800	2000
SP 400-1	5.5	7.5	HEAD IN METERS	28	27	26	25	24	23	21	19	18	16	13	10
SP 400-2-AB	7.5	10		39	38	37	36	35	34	31	27	22	17	10	3
SP 400-2-A	9.3	12.5		49	48	47	46	44	42	39	36	32	27	21	15
SP 400-2	11	15		56	55	54	52	50	47	44	40	37	33	28	22
SP 400-3-AA	13	17.5		68	66	64	62	60	58	54	49	43	35	26	16
SP 400-3-A	15	20		76	75	73	71	66	66	61	55	50	43	34	25
SP 400-3	18.5	25		84	83	80	78	75	72	66	61	56	50	42	33
SP 400-4-B	18.5	25		102	100	98	95	92	88	80	73	65	56	45	32
SP 400-4	22	30		113	112	109	106	103	98	89	82	75	68	57	44
SP 400-5-BB	22	30		122	119	116	114	110	106	97	88	78	66	51	35
SP 400-5	26	35		141	138	135	131	126	121	112	103	95	85	72	56
SP 400-6-B	30	40		158	156	152	147	142	136	125	115	104	92	76	57
SP 400-6	37	50		169	166	162	157	151	146	134	124	114	101	86	67
SP 400-7	37	50		198	195	191	186	180	174	159	146	133	120	101	80
SP 400-8	45	60		231	228	225	220	213	204	187	172	159	141	121	98
SP 400-9	55	75	262	259	254	247	238	229	210	195	179	160	138	110	
SP 400-10	55	75	290	287	281	274	265	255	235	217	199	178	152	123	
SP 400-11	63	85	317	313	308	301	293	282	258	237	218	196	168	135	
SP 400-12	63	85	347	342	337	330	319	307	280	259	23	215	183	147	
SP 400-13	75	100	375	370	365	357	346	332	305	280	258	230	198	160	
SP 400-14	92	125	404	399	393	384	373	359	328	302	277	247	210	168	
SP 400-15	92	125	433	428	421	411	399	384	351	324	297	264	225	180	

*Higher pressure , longer stages pumps up to 15 stages are available on request.

Dimensions and weights

Pump Type	Motor Dia.	Dimensions (mm)						Net Weight (Kg)
		5"Connection(RP,NPT)			5"Flange			
		A	C*	C**	A	C*	C**	
SP 400-1	6"	618	178	186	618	200	200	25.1
SP 400-2-AB	6"	746	178	186	746	200	200	28.7
SP 400-2-A	6"	746	178	186	746	200	200	28.7
SP 400-2	6"	746	178	186	746	200	200	28.7
SP 400-3-AA	6"	874	178	186	874	200	200	32.3
SP 400-3-A	6"	874	178	186	874	200	200	32.3
SP 400-3	6"	874	178	186	874	200	200	32.3
SP 400-4-B	6"	1003	178	186	1003	200	200	35.9
SP 400-4	6"	1003	178	186	1003	200	200	35.9
SP 400-5-BB	6"	1131	178	186	1131	200	200	39.5
SP 400-5	6"	1131	178	186	1131	200	200	39.5
SP 400-6-B	6"	1259	178	186	1259	200	200	43.0
SP 400-6	6"	1259	178	186	1259	200	200	43.0
SP 400-7	6"	1387	178	186	1387	200	200	46.6
SP 400-8	8"	1527	200	204	1527	205	205	51.6
SP 400-9	8"	655	200	204	655	205	205	55.2
SP 400-10	8"	1783	200	204	1783	205	205	58.8
SP 400-11	8"	1911	200	204	1911	205	205	62.4
SP 400-12	8"	2039	200	204	2039	205	205	66.0
SP 400-13	8"	2168	200	204	2168	205	205	69.6
SP 400-14	8"	2296	200	204				73.2
SP 400-15	8"	2424	200	204				76.8

C* : Maximum diameter of pump with one moter cable.
 C** : Maximum diameter of pump with two moter cable.

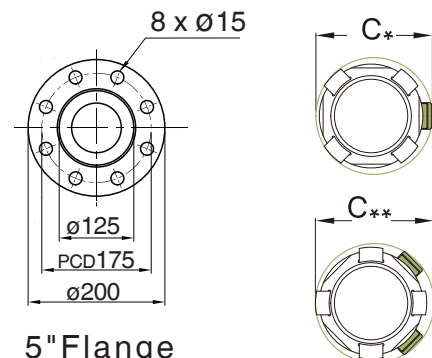
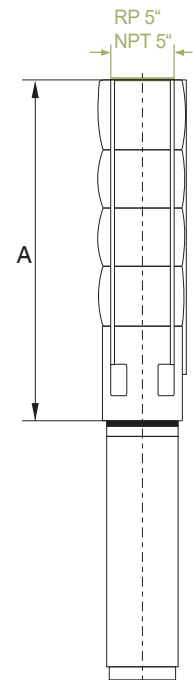

5" Flange

SP Series

SP 8"

SP500 Performance Curves

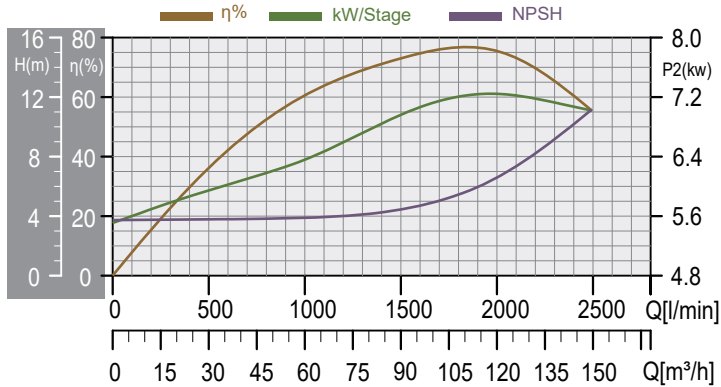
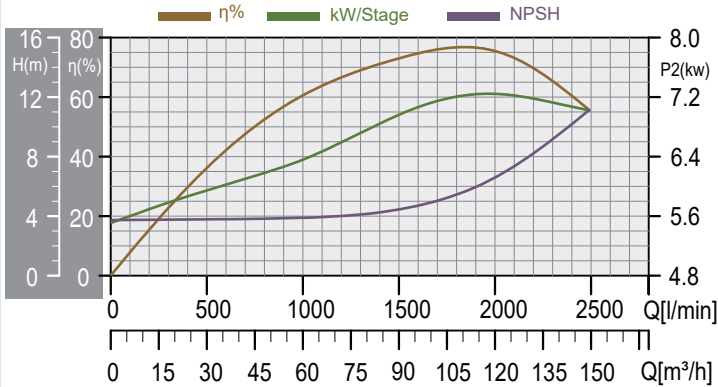
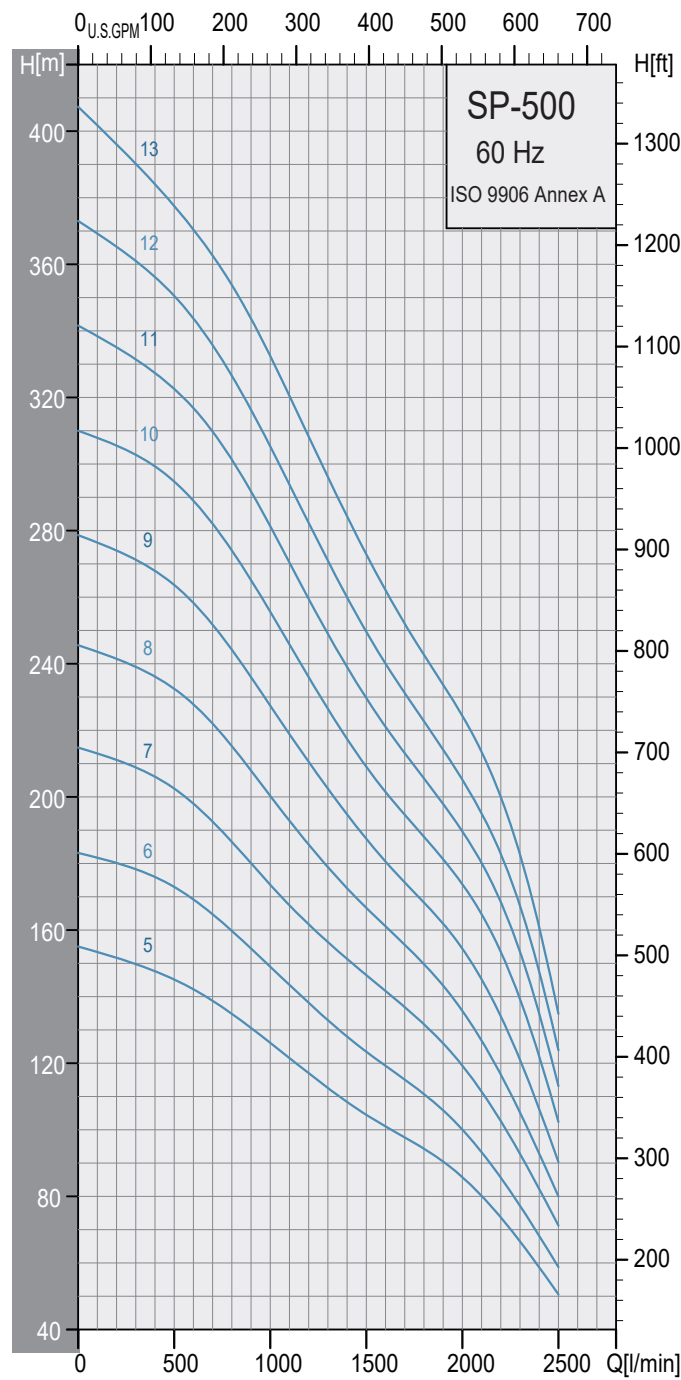
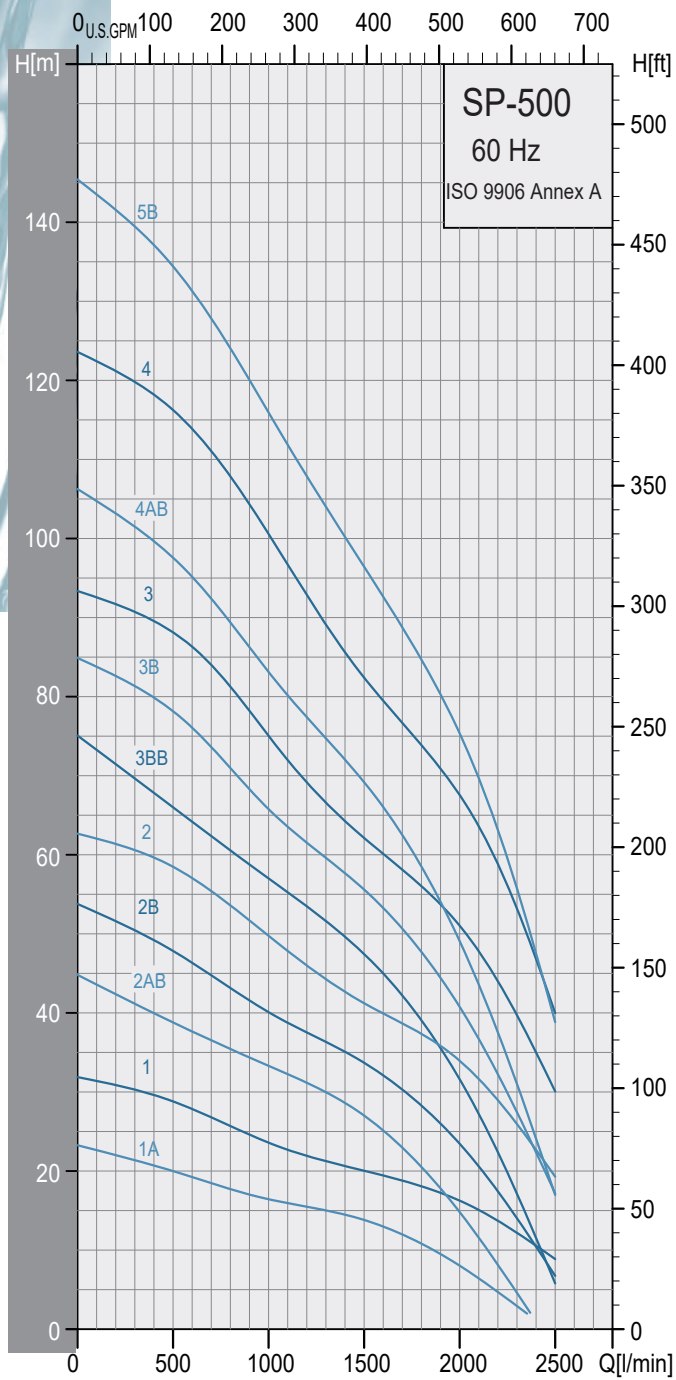

Selection Chart

Pump Type	Motor		m³/h l/min	Q capacity 3450 rpm											
	P2			18	30	42	54	66	78	90	102	114	126	138	150
	KW	HP		300	500	700	900	1100	1300	1500	1700	1900	2100	2300	2500
SP 500 - 1-A	5.5	7.5	21	20	18	17	16	15	14	12	9	6	3		
SP 500 - 1	7.5	10	30	29	26	25	23	21	20	19	17	15	12	9	
SP 500 - 2-AB	9.3	12.5	41	39	36	34	32	30	27	23	18	12	5		
SP 500 - 2-B	11	15	50	48	45	42	39	36	34	30	26	20	14	7	
SP 500 - 2	13	17.5	60	58	55	51	48	44	41	38	36	32	26	19	
SP 500 - 3-BB	15	20	70	66	62	59	55	51	47	42	35	27	17	6	
SP 500 - 3-B	18.5	25	81	78	74	68	64	60	55	51	45	37	27	17	
SP 500 - 3	22	30	91	88	84	78	72	66	62	58	54	48	40	30	
SP 500 - 4-AB	22	30	102	97	92	86	80	75	69	63	54	44	31	17	
SP 500 - 4	26	35	120	116	111	105	97	89	82	77	71	64	53	40	
SP 500 - 5-B	30	40	140	135	128	120	112	104	96	89	80	70	55	39	
SP 500 - 5	37	50	150	145	139	130	121	112	105	98	90	80	67	50	
SP 500 - 6	37	50	178	172	165	154	143	132	123	115	106	93	77	59	
SP 500 - 7	45	60	209	202	192	180	167	156	147	137	126	111	92	71	
SP 500 - 8	55	75	239	232	221	208	192	179	167	156	143	127	105	80	
SP 500 - 9	63	85	271	263	251	236	220	201	188	174	161	145	120	90	
SP 500 - 10	63	85	302	295	281	265	246	227	210	194	180	165	140	103	
SP 500 - 11	75	100	331	322	310	291	270	250	230	213	198	180	153	114	
SP 500 - 12	93	125	360	350	336	316	294	270	250	231	214	195	168	124	
SP 500 - 13	93	125	390	378	362	344	320	296	272	252	233	213	182	136	

HEAD IN METERS

Dimensions and weights

Pump Type	Motor Dia.	Dimensions (mm)						Net Weight (Kg) Pump
		5" Connection (RP, NPT)			5" Flange			
		A	C*	C**	A	C*	C**	
SP 500 - 1-A	6"	618	179	183	618	200	200	25.1
SP 500 - 1	6"	618	179	183	618	200	200	25.1
SP 500 - 2-AB	6"	746	179	183	746	200	200	28.7
SP 500 - 2-B	6"	746	179	183	746	200	200	28.7
SP 500 - 2	6"	746	179	183	746	200	200	28.7
SP 500 - 3-BB	6"	874	179	183	874	200	200	32.3
SP 500 - 3-B	6"	874	179	183	874	200	200	32.3
SP 500 - 3	6"	874	179	183	874	200	200	32.3
SP 500 - 4-AB	6"	1003	179	183	1003	200	200	35.9
SP 500 - 4	6"	1003	179	183	1003	200	200	35.9
SP 500 - 5-B	6"	1131	179	183	1131	200	200	39.5
SP 500 - 5	6"	1131	179	183	1131	200	200	39.5
SP 500 - 6	6"	1259	179	183	1259	200	200	43
SP 500 - 7	8"	1398	205	205	1398	200	202	48
SP 500 - 8	8"	1527	205	205	1527	200	202	51.6
SP 500 - 9	8"	1655	205	205	1655	200	202	55.2
SP 500 - 10	8"	1783	205	205	1783	200	202	58.8
SP 500 - 11	8"	1911	205	205	1911			62.4
SP 500 - 12	8"	2039	205	205	2039			66
SP 500 - 13	8"	2168	205	205	2168			69.6

C*: Maximum diameter of pump with one motor cable
 C**: Maximum diameter of pump with two motor cable

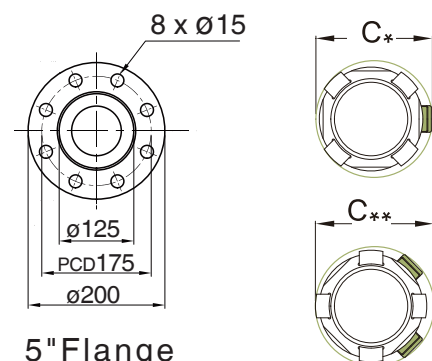
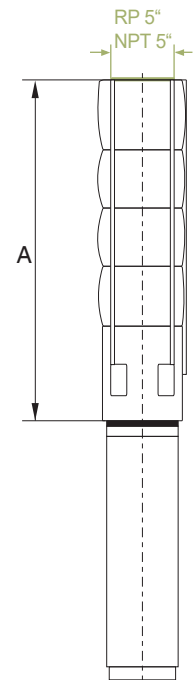

5" Flange

SP Series

SP 10"

SP650 Performance Curves

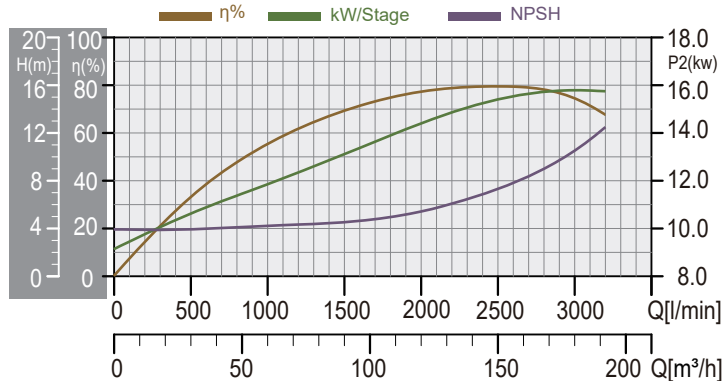
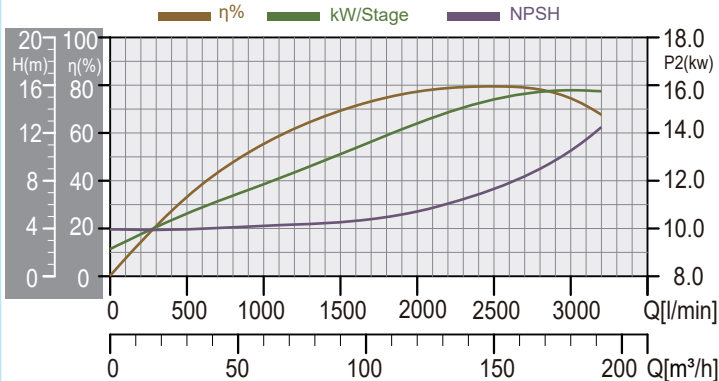
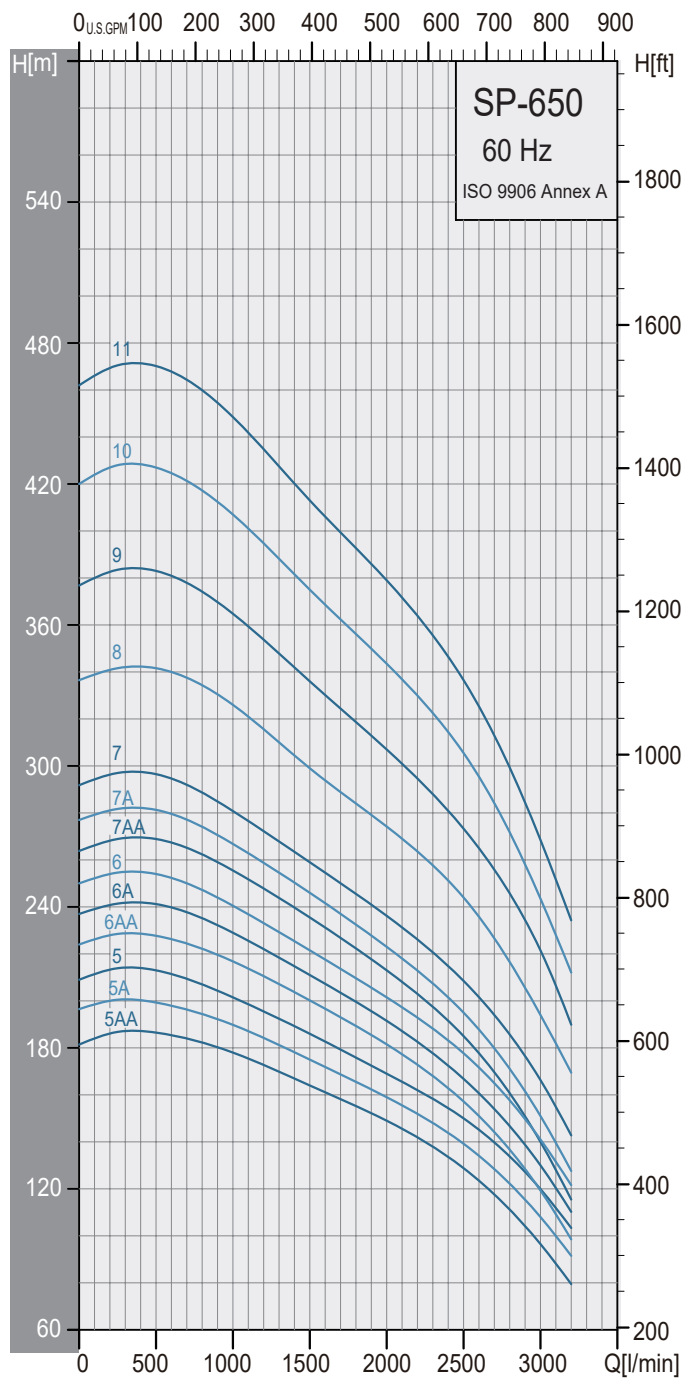
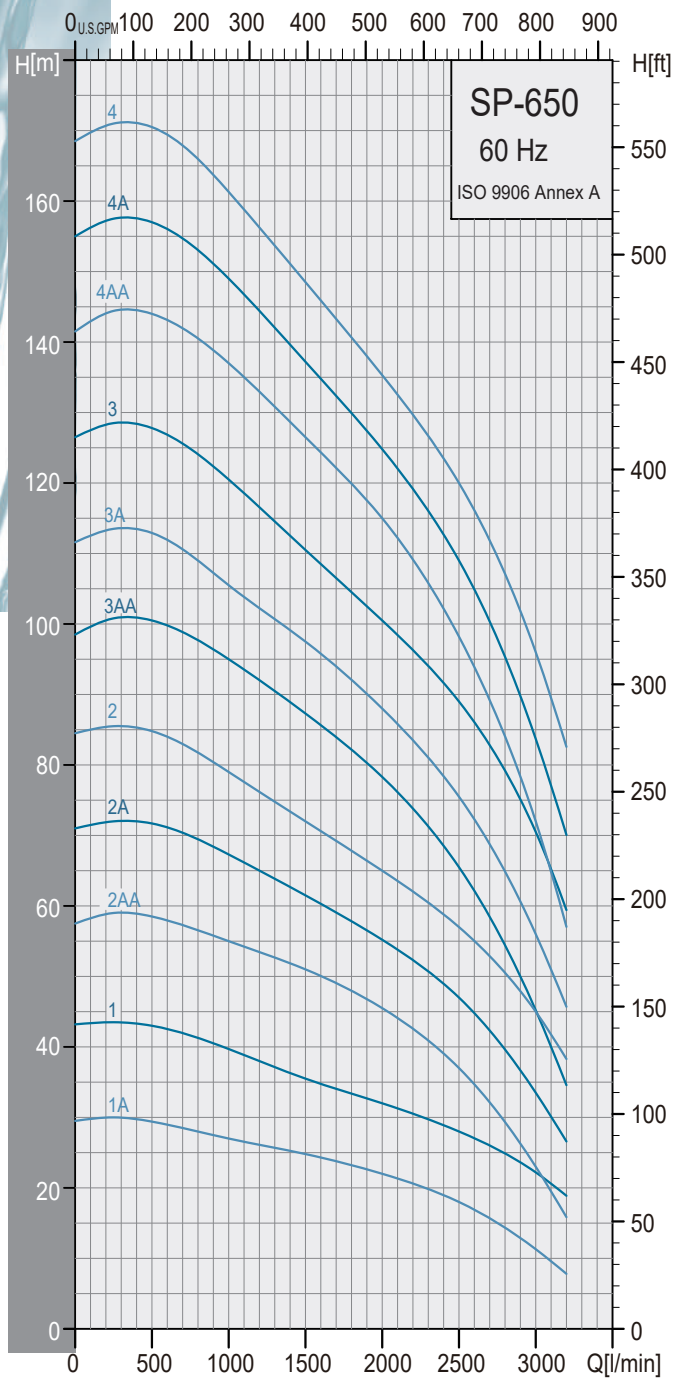

Selection Chart

60Hz

Dimensions and weights

Pump Type	Motor		m ³ /h l/min	Q capacity 3450 rpm											
	P2			48	60	72	84	96	108	120	132	144	156	168	180
	KW	HP		800	1000	1200	1400	1600	1800	2000	2200	2400	2600	2800	3000
SP650-1-A	11	15	28	27	26	25	24	23	22	21	19	17	14	11	
SP650-1	18.5	25	41	40	38	46	35	34	32	31	29	27	25	22	
SP650-2-AA	22	30	57	55	58	52	50	48	46	43	39	35	29	23	
SP650-2-A	26	35	69	67	65	63	60	58	55	53	49	45	40	34	
SP650-2	30	40	82	79	76	73	71	68	65	63	59	55	51	45	
SP650-3-AA	37	50	98	95	92	89	86	82	78	74	69	62	55	45	
SP650-3-A	37	50	109	107	103	99	96	92	88	83	78	72	65	56	
SP650-3	45	60	124	121	117	113	108	105	101	96	92	86	79	71	
SP650-4-AA	55	75	141	137	133	139	124	120	115	109	102	94	84	72	
SP650-4-A	55	75	153	149	144	140	135	130	125	119	113	105	95	84	
SP650-4	63	85	166	161	151	151	146	141	135	130	123	116	107	96	
SP650-5-AA	75	100	182	178	173	167	161	155	149	142	133	123	111	97	
SP650-5-A	75	100	195	190	185	178	171	165	159	152	143	135	122	108	
SP650-5	75	100	207	202	196	190	183	176	169	162	155	145	134	120	
SP650-6-AA	75	100	223	217	210	204	196	190	182	173	163	151	137	119	
SP650-6-A	93	125	235	229	222	215	208	200	192	183	173	160	147	130	
SP650-6	93	125	247	241	233	225	218	210	202	193	183	171	157	141	
SP650-7-AA	93	125	262	256	248	240	231	222	213	203	192	177	161	140	
SP650-7-A	93	125	274	267	258	250	241	233	223	213	201	188	171	151	
SP650-7	110	150	288	281	273	263	255	246	236	226	215	201	185	166	
SP650-8	132	175	334	326	315	305	294	284	274	263	251	236	217	194	
SP650-9	132	175	374	365	354	342	330	318	307	295	281	265	245	222	
SP650-10	147	200	417	407	395	381	369	356	344	330	315	295	272	244	
SP650-11	170	230	460	449	435	420	406	393	379	364	346	325	299	269	

HEAD IN METERS

Pump Type	Motor Dia.	Dimensions (mm)			Net Weight (Kg) Pump
		A	C*	C**	
SP650-1-A	6"	652	211	215	29.2
SP650-1	6"	652	211	215	29.3
SP650-2-AA	6"	807	211	215	35.6
SP650-2-A	6"	807	211	215	35.7
SP650-2	6" 8"	807	211 213	215 219	35.8 42.1
SP650-3-AA	6" 8"	963	211 213	215 219	42.1 46.9
SP650-3-A	6" 8"	963	211 213	215 219	42.2 47.0
SP650-3	6" 8"	963	211 213	215 219	42.3 47.1
SP650-4-AA	8"	1118	213	219	51.9
SP650-4-A	8"	1118	213	219	52.0
SP650-4	8"	1118	213	219	52.1
SP650-5-AA	8"	1274	213	219	56.9
SP650-5-A	8"	1274	213	219	57.0
SP650-5	8"	1274	213	219	57.1
SP650-6-AA	8"	1429	213	219	61.9
SP650-6-A	8"	1429	213	219	62.0
SP650-6	8"	1429	213	219	62.1
SP650-7-AA	8"	1585	213	219	66.9
SP650-7-A	8"	1585	213	219	67.0
SP650-7	8"	1585	213	219	67.1
SP650-8	10"	1870	227	247	83.5
SP650-9	10"	2026	227	247	90.0
SP650-10	10"	2181	227	247	96.5
SP650-11	10"	2337	227	247	103.0

C*: Maximum diameter of pump with one motor cable
C**: Maximum diameter of pump with two motor cable

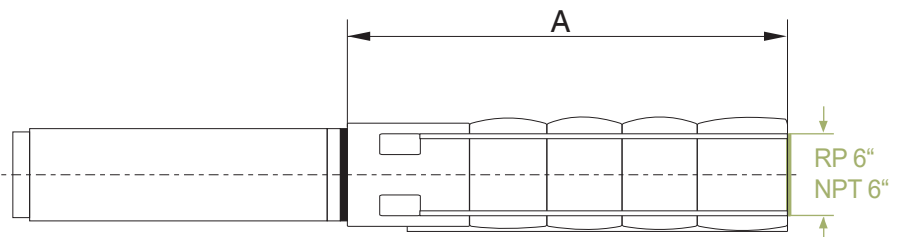
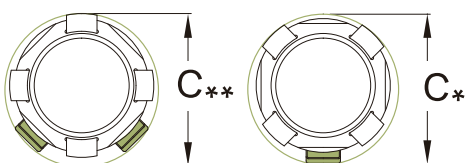

SP Series

SP10"

SP800 Performance Curves

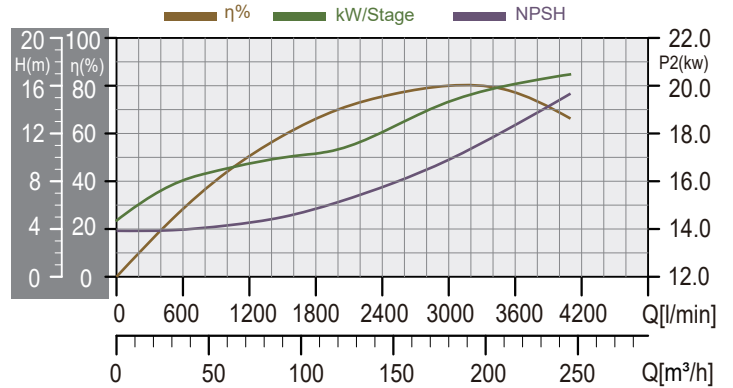
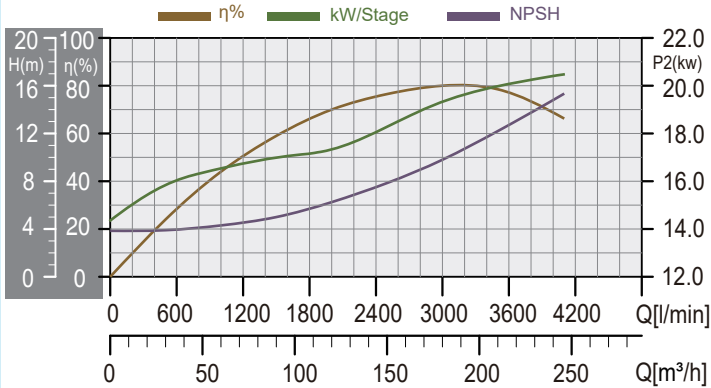
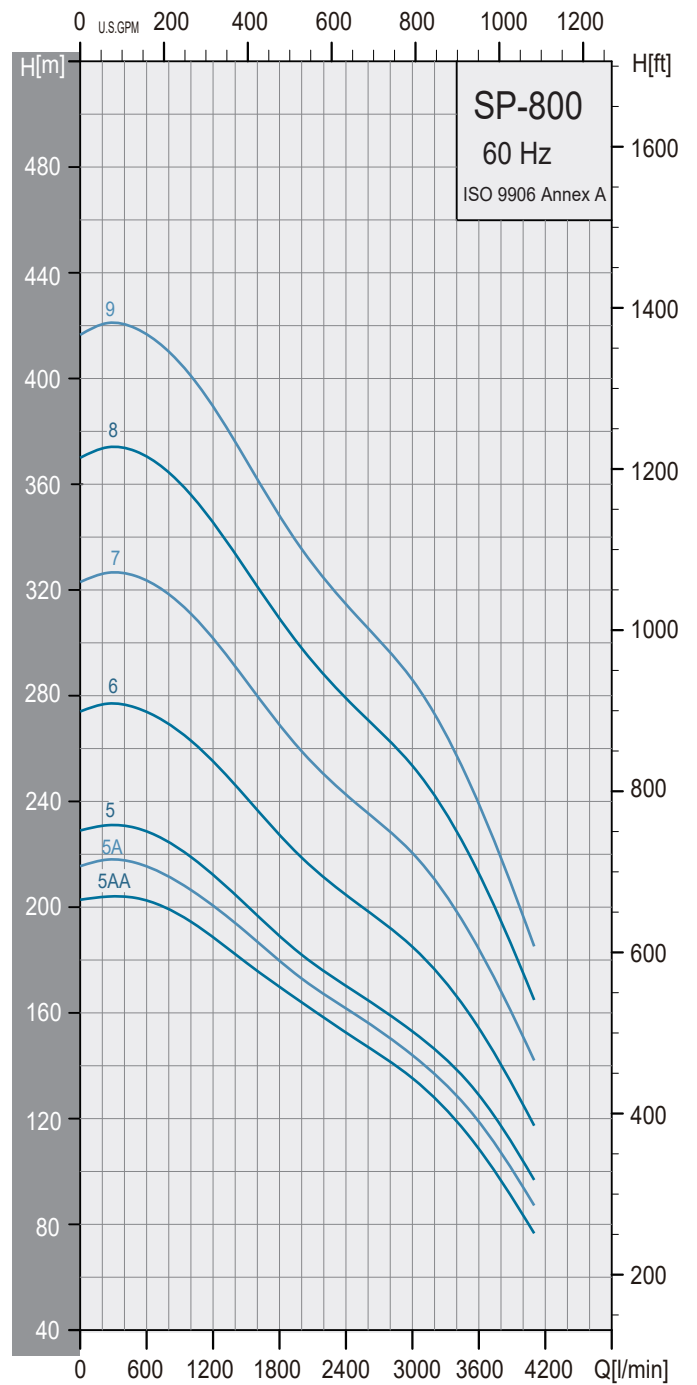
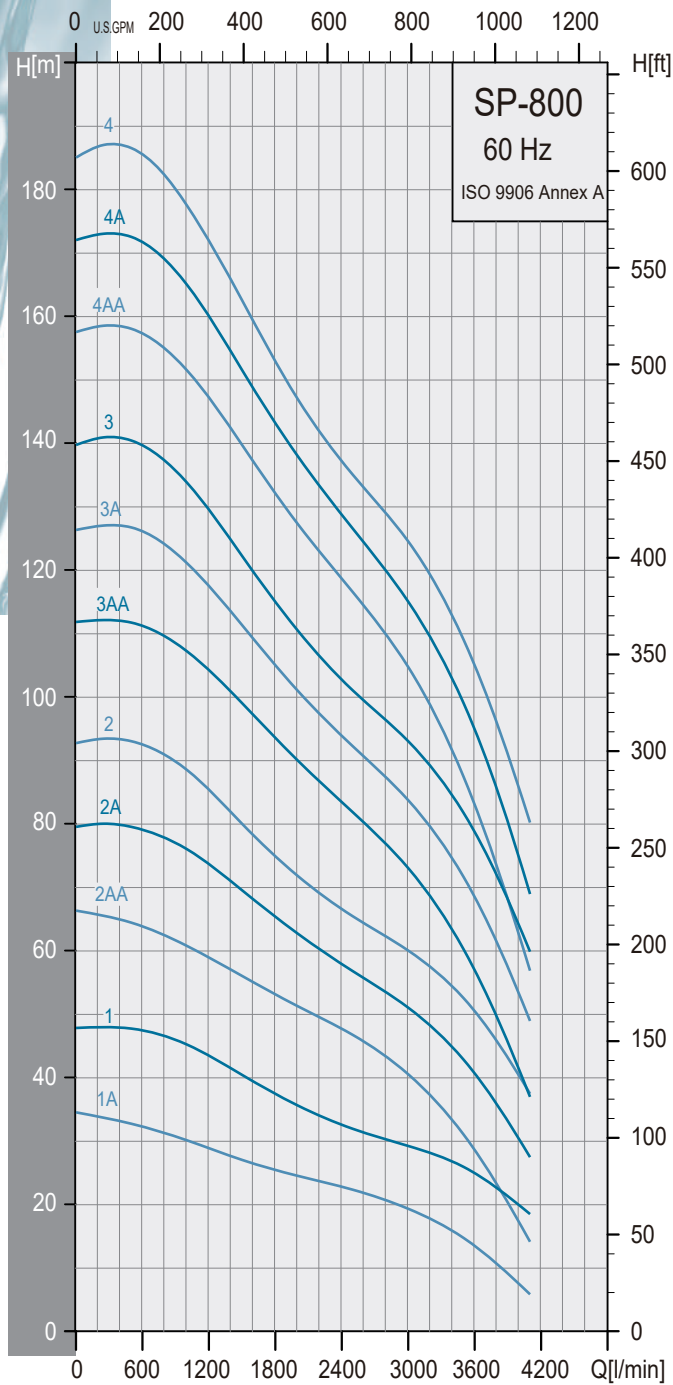

Selection Chart

60Hz

Pump Type	Motor		Q capacity 3450 rpm												
	P2		m³/h l/min	36	54	72	90	108	126	144	162	180	198	216	234
	KW	HP		600	900	1200	1500	1800	2100	2400	2700	3000	3300	3600	3900
SP 800-1-A	15	20	HEAD IN METERS	32	31	29	27	26	24	23	21	19	17	13	9
SP 800-1	22	30		47	46	44	40	37	35	33	31	29	28	25	21
SP 800-2-AA	26	35		64	62	59	56	53	50	48	45	41	35	28	20
SP 800-2-A	37	50		79	77	74	70	65	62	58	55	51	47	41	33
SP 800-2	37	50		93	90	85	80	75	70	67	63	60	56	50	43
SP 800-3-AA	45	60		111	108	104	99	93	88	83	78	73	66	57	46
SP 800-3-A	55	75		126	122	118	111	105	99	94	89	84	77	68	57
SP 800-3	55	75		140	136	130	123	115	108	103	98	93	87	79	68
SP 800-4-AA	63	85		157	153	147	140	132	125	119	112	105	96	83	68
SP 800-4-A	75	100		172	167	160	152	143	136	129	122	115	107	95	80
SP 800-4	75	100		186	180	172	163	153	145	138	131	125	117	105	91
SP 800-5-AA	93	125		202	197	188	179	170	161	153	144	135	124	108	90
SP 800-5-A	93	125		216	209	201	191	180	170	162	153	144	133	119	101
SP 800-5	93	125		228	222	212	201	189	178	170	162	153	143	129	111
SP 800-6	110	150		274	267	255	242	227	215	205	195	185	172	154	133
SP 800-7	132	175		323	315	302	286	269	255	242	232	221	205	184	160
SP 800-8	147	200		370	361	346	328	309	293	279	267	254	235	213	185
SP 800-9	170	230		417	406	389	369	348	330	314	301	286	266	239	208

Dimensions and weights

Pump Type	Motor Dia.	Dimensions (mm)			Net Weight (Kg)
		6" Connection (RP, NPT)			
		A	C*	C**	
SP 800-1-A	6"	652	211	215	30.4
SP 800-1	6"	652	211	215	30.4
SP 800-2-AA	6"	807	211	215	36.7
SP 800-2-A	6"	807	211	215	36.8
SP 800-2	6"	807	211	215	36.8
SP 800-3-AA	8"	963	213	219	44.5
SP 800-3-A	8"	963	213	219	44.6
SP 800-3	8"	963	213	219	44.6
SP 800-4-AA	8"	1118	213	219	50.9
SP 800-4-A	8"	1118	213	219	51.0
SP 800-4	8"	1118	213	219	51.0
SP 800-5-AA	8"	1274	213	219	57.3
SP 800-5-A	8"	1274	213	219	57.4
SP 800-5	8"	1274	213	219	57.4
SP 800-6	8"	1429	213	219	63.8
SP 800-7	10"	1715	227	247	83.4
SP 800-8	10"	1870	227	247	89.8
SP 800-9	10"	2026	227	247	96.2

C*: Maximum diameter of pump with one motor cable
 C**: Maximum diameter of pump with two motor cable

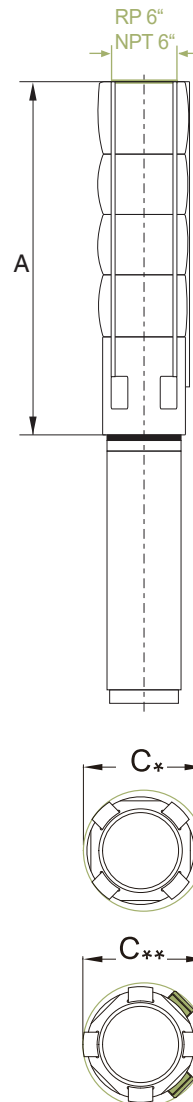

SP Series

SP10"

SP1100

Performance Curves

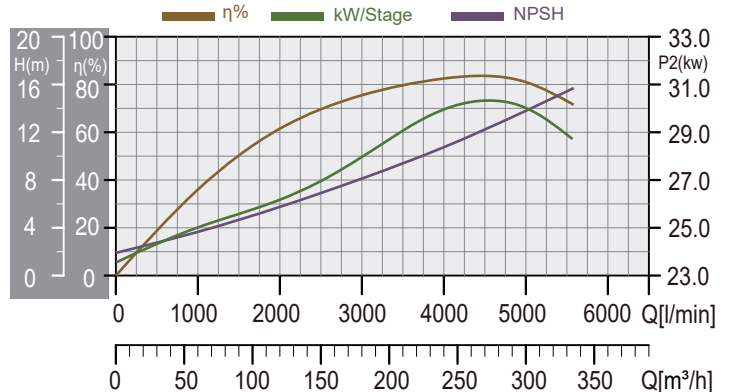
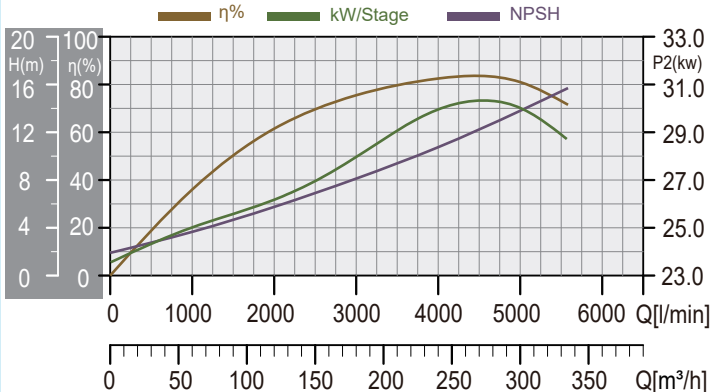
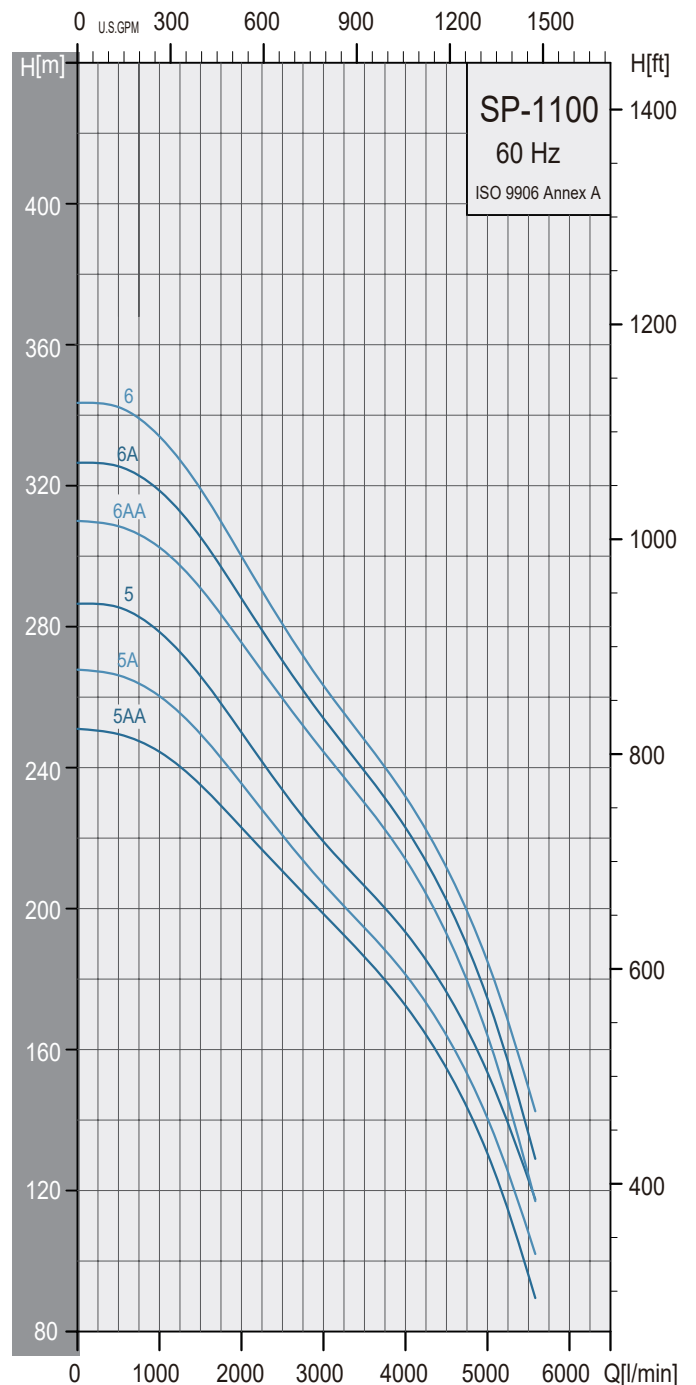
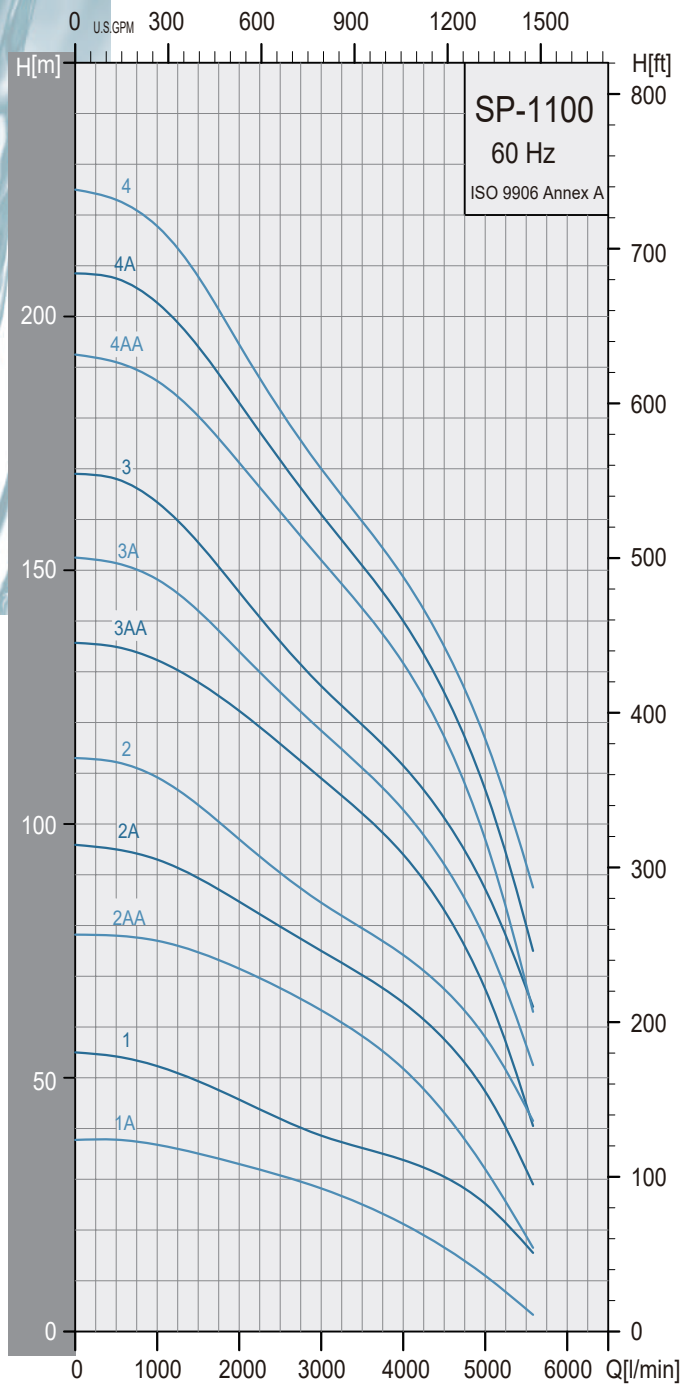

Selection Chart

60Hz

Pump Type	Motor		m ³ /h l/min	Q capacity 3450 rpm										
	P2			30	60	90	120	150	180	210	240	270	300	330
	KW	HP		500	1000	1500	2000	2500	3000	3500	4000	4500	5000	5500
SP 1100-1-A	22	30	HEAD IN METERS	38	37	35	33	31	28	25	21	16	11	5
SP 1100-1	30	40		54	52	49	46	42	38	36	34	30	25	17
SP 1100-2-AA	45	60		78	77	74	71	67	63	58	52	43	32	19
SP 1100-2-A	55	75		95	93	89	85	80	75	70	65	57	47	33
SP 1100-2	63	85		112	109	103	97	90	84	79	74	67	58	45
SP 1100-3-AA	75	100		135	132	128	122	116	109	102	94	83	67	46
SP 1100-3-A	93	125		151	148	142	134	126	118	111	103	92	77	57
SP 1100-3	93	125		168	163	155	146	321	127	119	111	101	87	69
SP 1100-4-AA	110	150		191	187	180	171	161	152	142	131	117	97	70
SP 1100-4-A	110	150		207	202	194	183	171	161	151	140	126	107	81
SP 1100-4	110	150		223	218	208	194	181	170	159	148	135	117	93
SP 1100-5-AA	132	175		249	244	235	223	210	198	186	172	154	130	98
SP 1100-5-A	132	175		266	260	249	235	221	207	194	181	164	140	110
SP 1100-5	147	200		285	278	266	250	233	219	206	193	176	153	125
SP 1100-6-AA	170	230		308	302	291	275	260	244	230	214	192	164	126
SP 1100-6-A	170	230		325	318	305	288	270	254	239	223	202	174	138
SP 1100-6	170	230		342	334	319	300	281	263	248	232	211	185	151

Dimensions and weights

Pump Type	Motor Dia.	Dimensions (mm)			Net Weight (Kg)
		6" Connection (RP, NPT)			
		A	C*	C**	
SP 1100-1-A	6"	772	237	241	46.1
SP 1100-1	6"	772	237	241	46.1
SP 1100-2-AA	8"	948	237	241	55.8
SP 1100-2-A	8"	948	237	241	55.8
SP 1100-2	8"	948	237	241	55.8
SP 1100-3-AA	8"	1124	237	241	65.6
SP 1100-3-A	8"	1124	237	241	65.6
SP 1100-3	8"	1124	237	241	65.6
SP 1100-4-AA	8"	1300	237	241	75.4
SP 1100-4-A	8"	1300	237	241	75.4
SP 1100-4	8"	1300	237	241	75.4
SP 1100-5-AA	10"	1476	262	274	90.8
SP 1100-5-A	10"	1476	262	274	90.8
SP 1100-5	10"	1476	262	274	90.8
SP 1100-6-AA	10"	1652	262	274	101.0
SP 1100-6-A	10"	1652	262	274	101.0
SP 1100-6	10"	1652	262	274	101.0

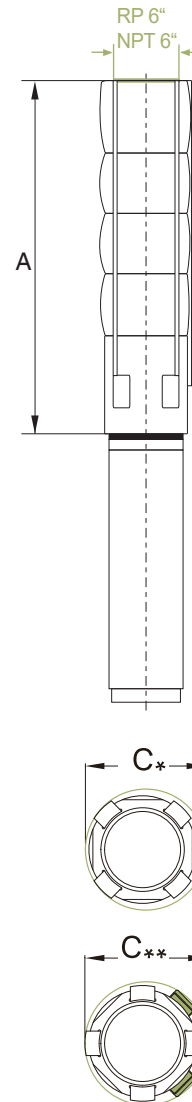

C*: Maximum diameter of pump with one motor cable
 C**: Maximum diameter of pump with two motor cable



www.sistema-pumps.com